

MOSFET 75A 500V

**PDM755HA
P2HM755HA**

PDM755HA

P2HM755HA

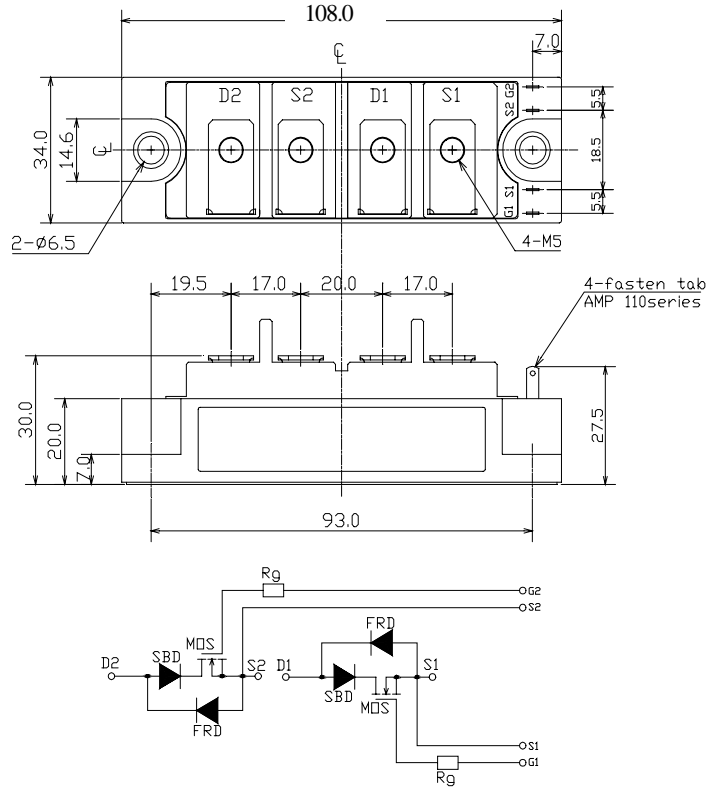
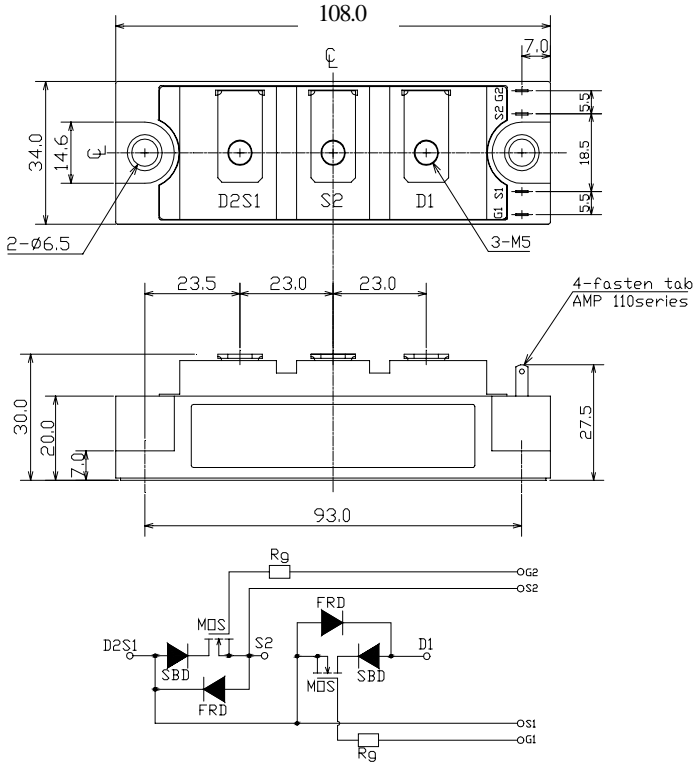

質量 Approximate Weight :220g

質量 Approximate Weight :220g

最大定格 Maximum Ratings

項目 Rating	目	記号 Symbol	耐圧・クラス Grade	単位 Unit
			PDM755HA / P2HM755HA	
ドレイン・ソース間電圧 Drain-Source Voltage		V_{DSS}	500 $V_{GS}=0V$	V
ゲート・ソース間電圧 Gate-Source Voltage		V_{GSS}	± 20	V
ドレイン電流 (連続) Continuous Drain Current	Duty=50%	I_D	75 ($T_c=25$)	A
	D.C.		53 ($T_c=25$)	
パルスドレイン電流 Pulsed Drain Current		I_{DM}	150 ($T_c=25$)	A
全損失 Total Power Dissipation		P_D	500 ($T_c=25$)	W
動作接合温度範囲 Operating Junction Temperature Range		T_{jw}	- 40 ~ +150	
保存温度範囲 Storage Temperature Range		T_{stg}	- 40 ~ +125	
絶縁耐圧 RMS Isolation Voltage		V_{iso}	2000	V
			端子 - ベース間, AC1 分間 Terminals to Base, AC 1 min .	
締付トルク Mounting Torque		F_{tor}	3.0 (本体取付 Module Base to Heat sink)	N · m
			2.0 (ネジ端子部 Bus bar to Main Terminals)	

電気的特性 Electrical Characteristics (@Tc = 25 unless otherwise noted)

項目 Characteristic	記号 Symbol	条件 Condition	特性値(最大) Maximum Value			単位 Unit
			最小 Min.	標準 Typ.	最大 Max.	
ドレイン遮断電流 Zero Gate Voltage Drain Current	IDSS	V _{DS} = V _{DSS} , V _{GS} = 0V			1	mA
		T _J = 125, V _{DS} = V _{DSS} , V _{GS} = 0V			4	
ゲート・ソース間しきい値電圧 Gate-Source Threshold Voltage	V _{GS(th)}	V _{DS} = V _{GS} , I _D = 5mA	2	2.9	4	V
ゲート・ソース間漏れ電流 Gate-Source Leakage Current	I _{GSS}	V _{GS} = ±20V, V _{DS} = 0V			10	μA
ドレイン・ソース間オン抵抗(MOSFET部) Static Drain-Source On-Resistance	r _{D(on)}	V _{GS} = 10V, I _D = 35A		55	65	m
ドレイン・ソース間オン電圧 Drain-Source On-Voltage	V _{D(on)}	V _{GS} = 10V, I _D = 35A		2.4	2.9	V
順伝達コンダクタンス Forward Transconductance	g _{fg}	V _{DS} = 15V, I _D = 35A		75		S
入力容量 Input Capacitance	C _{iss}	V _{GS} = 0V V _{DS} = 25V f = 1MHz		16		nF
出力容量 Output Capacitance	C _{oss}			1.8		nF
帰還容量 Reverse Transfer Capacitance	C _{rss}			0.4		nF
ターン・オン遅延時間 Turn-On Delay Time	t _{d(on)}			180		ns
上昇時間 Rise Time	t _r	V _{DD} = 1/2V _{DSS} I _D = 35A		70		ns
ターン・オフ遅延時間 Turn-Off Delay Time	t _{d(off)}	V _{GS} = -5V, +10V R _G = 5		390		ns
下降時間 Fall Time	t _f			50		ns

内部ダイオード定格・特性 Source-Drain Diode Ratings and Characteristics (@Tc = 25 unless otherwise noted)

項目 Characteristic	記号 Symbol	条件 Condition	特性値(最大) Maximum Value			単位 Unit
			最小 Min.	標準 Typ.	最大 Max.	
ソース電流(連続) Continuous Source Current	I _S	D. C.			53	A
パルスソース電流 Pulsed Source Current	I _{SM}				150	A
ダイオード順電圧 Diode Forward Voltage	V _{SD}	I _S = 75A			1.8	V
逆回復時間 Reverse Recovery Time	t _{rr}	I _S = 75A - dis/dt = 100A/μs		70		ns
逆回復電荷 Reverse Recovery Charge	Q _r			0.15		μC

熱抵抗特性 Thermal Characteristics

項目 Characteristic	記号 Symbol	条件 Condition	特性値(最大) Maximum Value			単位 Unit
			最小 Min.	標準 Typ.	最大 Max.	
熱抵抗(接合部 - ケース間) Thermal Resistance, Junction to Case	R _{th(j-c)}	MOSFET			0.25	/W
		Diode			2.0	
接触熱抵抗(ケース - 冷却フィン間) Thermal Resistance, Case to Heatsink	R _{th(c-f)}	サーマルコンパウンド塗布 Mounting surface flat, smooth, and greased			0.1	

定格・特性曲線

Fig. 1 Typical Output Characteristics

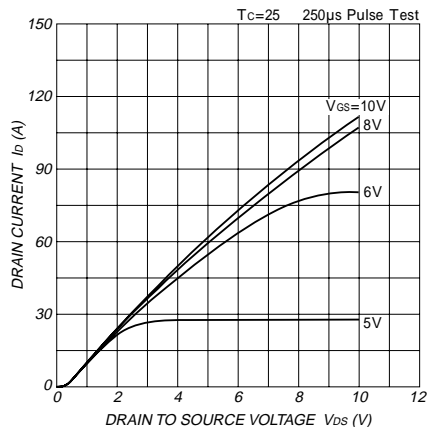

Fig. 2 Typical Drain-Source On-Voltage Vs. Gate-Source Voltage

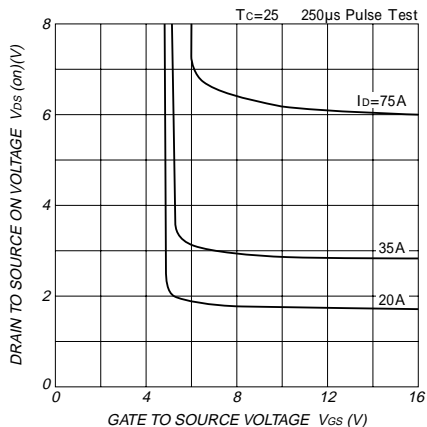

Fig. 3 Typical Drain-Source On Voltage Vs. Junction Temperature

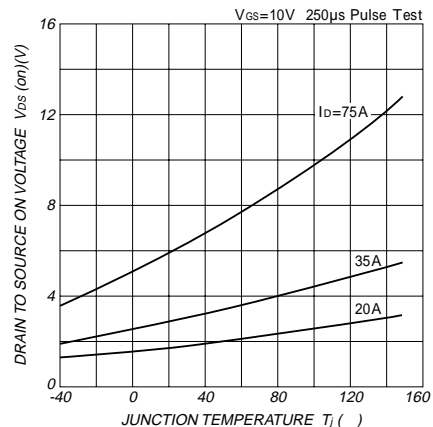

Fig. 4 Typical Capacitance Vs. Drain-Source Voltage

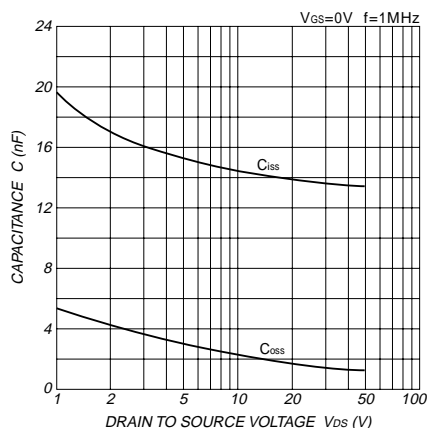

Fig. 5 Typical Gate Charge Vs. Gate-Source Voltage

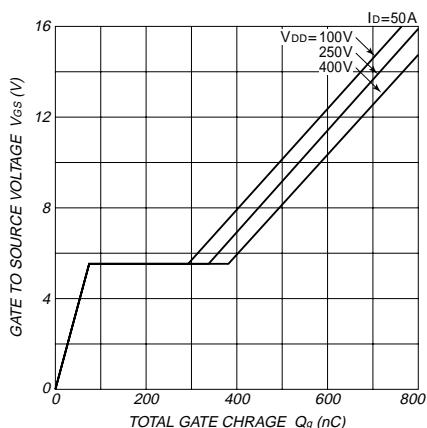

Fig. 6 Typical Switching Time Vs. Series Gate Impedance

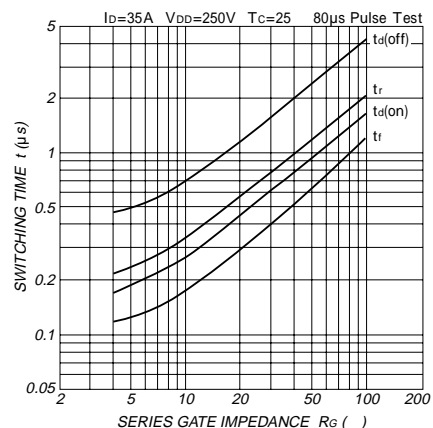

Fig. 7 Typical Switching Time Vs. Drain Current

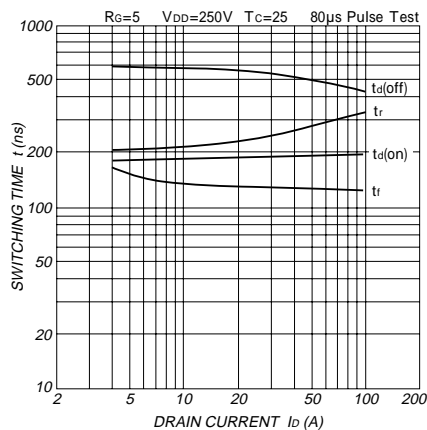

Fig. 8 Typical Source-Drain Diode Forward Characteristics

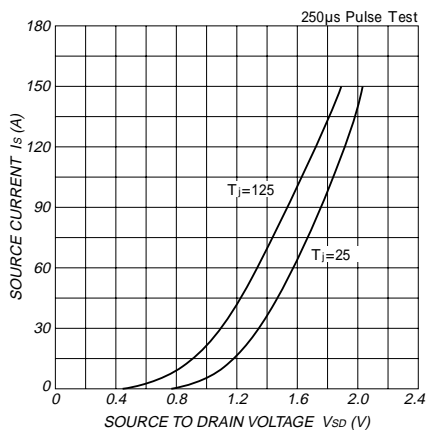

Fig. 9 Typical Reverse Recovery Characteristics

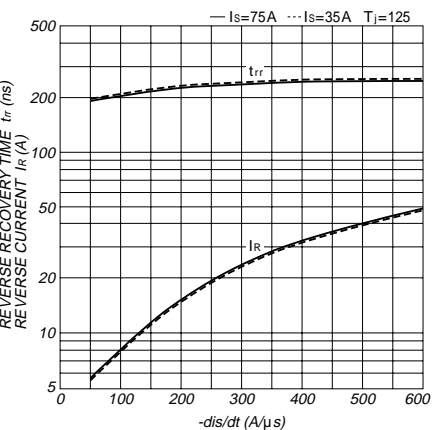

Fig. 10 Maximum Safe Operating Area

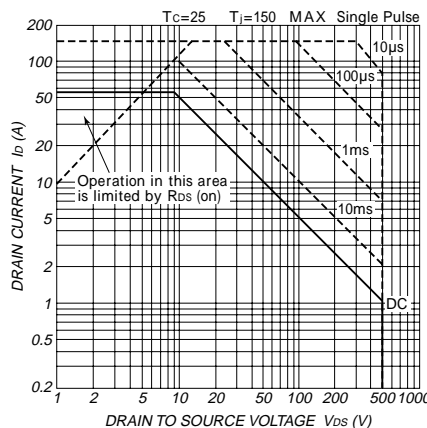

Fig. 11-1 Normalized Transient Thermal Impedance(MOSFET)

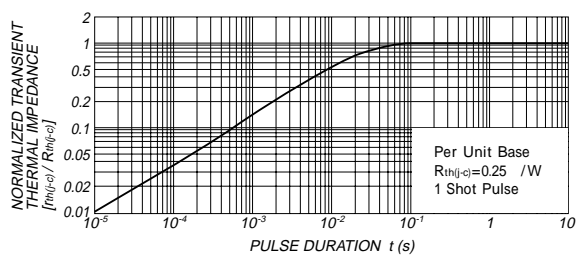
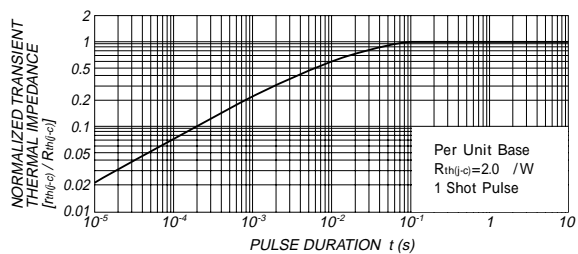

Fig. 11-2 Normalized Transient Thermal Impedance(DIODE)



MOSFETデータシート