

# THYRISTOR

## 150A Avg 1600 Volts

PDT15016 PDH15016  
PCH15016 PAT15016  
PAH15016

### ■回路図 CIRCUIT

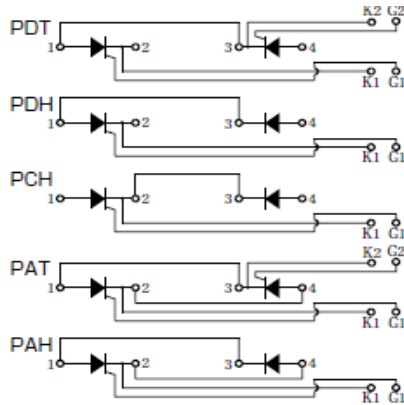

### ■外形寸法図 OUTLINE DRAWING

Dimension: [mm]

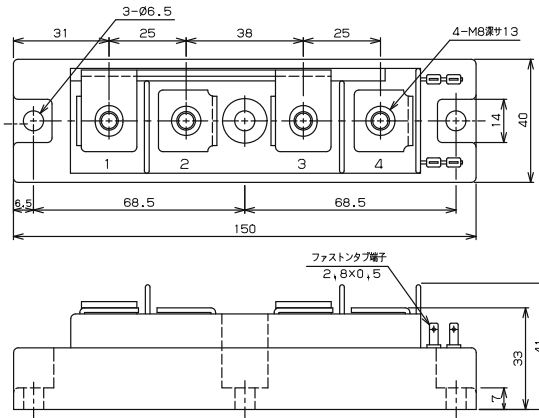

### ■最大定格 Maximum Ratings

項目 Parameter	記号 Symbol	耐圧クラス Grade	単位 Unit
		PDT/PDH/PCH/PAT/PAH15016	
くり返しピークオフ電圧 Repetitive Peak Off-State Voltage	$V_{DRM}$	1600	V
非くり返しピークオフ電圧 Non Repetitive Peak Off-State Voltage	$V_{DSM}$	1700	V
くり返しピーク逆電圧 Repetitive Peak Reverse Voltage	$V_{RRM}$	1600	V
非くり返しピーク逆電圧 Non Repetitive Peak Reverse Voltage	$V_{RSM}$	1700	V

項目 Parameter	記号 Symbol	条件 Conditions	定格値 Max. Rated Value	単位 Unit		
		商用周波数 180° 通電 $T_c = 73^\circ\text{C}$ Half Sine Wave				
平均オン電流 Average On-State Current	$I_{O(AV)}$		150	A		
実効オン電流 RMS On-State Current	$I_{TRMS}$		235	A		
サージオン電流 Surge On-State Current	$I_{ISM}$	50Hz 正弦半波, 1サイクル, 非くり返し Half Sine Wave, 1Pulse, Non-Repetitive	3200	A		
電流二乗時間積 $I^2 \text{ Squared } t$	$I^2 t$	2~10ms	51200	$\text{A}^2 \text{ s}$		
臨界オン電流上昇率 Critical Rate of Rise of Turned-On Current	$di/dt$	$V_D = 2/3 V_{DRM}$ , $I_{TM} = 2 \cdot I_O$ , $T_j = 125^\circ\text{C}$ $I_G = 300\text{mA}$ , $di/dt = 0.2\text{A}/\mu\text{s}$	100	$\text{A}/\mu\text{s}$		
ピークゲート電力損失 Peak Gate Power	$P_{GM}$		5	W		
平均ゲート電力損失 Average Gate Power	$P_{G(AV)}$		1	W		
ピークゲート電流 Peak Gate Current	$I_{GM}$		2	A		
ピークゲート電圧 Peak Gate Voltage	$V_{GM}$		10	V		
ピークゲート逆電圧 Peak Gate Reverse Voltage	$V_{RGM}$		5	V		
動作接合温度範囲 Operating Junction Temperature Range	$T_{jw}$		-40 ~ +125	$^\circ\text{C}$		
保存温度範囲 Storage Temperature Range	$T_{stg}$		-40 ~ +125	$^\circ\text{C}$		
絶縁耐圧 Isolation Voltage	$V_{iso}$	端子—ベース間, AC 1分間 Terminal to Base, AC 1min.	2500	V		
締付トルク Mounting Torque	ベース部 Mounting	F	サマロノパウンド 塗布 Greased	M6	2.5 ~ 3.5	$\text{N} \cdot \text{m}$
	主端子部 Terminal		M8	9.0 ~ 10.0	$\text{N} \cdot \text{m}$	

■電気的特性 Electrical Characteristics

項目 Parameter	記号 Symbol	条件 Conditions	特性値 (最大) Maximum Value			単位 Unit
			最小 Min.	標準 Typ.	最大 Max.	
ピークオフ電流 Peak Off-State Current	$I_{DM}$	$T_j=125^\circ\text{C}$ , $V_{DM}=V_{DRM}$			50	mA
ピーク逆電流 Peak Reverse Current	$I_{RM}$	$T_j=125^\circ\text{C}$ , $V_{RM}=V_{RRM}$			50	mA
ピークオン電圧 Peak On-State Voltage	$V_{TM}$	$T_j=25^\circ\text{C}$ , $I_{TM}=450\text{A}$			1.38	V
トリガゲート電流 Gate Current to Trigger	$I_{GT}$	$V_D=6\text{V}$ , $I_T=1\text{A}$	$T_j=-40^\circ\text{C}$		300	mA
			$T_j=25^\circ\text{C}$		150	mA
			$T_j=125^\circ\text{C}$		80	mA
			$T_j=-40^\circ\text{C}$		5	V
トリガゲート電圧 Gate Voltage to Trigger	$V_{GT}$	$V_D=6\text{V}$ , $I_T=1\text{A}$	$T_j=-40^\circ\text{C}$		5	V
			$T_j=25^\circ\text{C}$		3	V
			$T_j=125^\circ\text{C}$		2	V
			$T_j=125^\circ\text{C}$		2	V
非トリガゲート電圧 Gate Non-Trigger Voltage	$V_{GD}$	$T_j=125^\circ\text{C}$ , $V_D=2/3V_{DRM}$	0.25			V
臨界オフ電圧上昇率 Critical Rate of Rise of Off-State Voltage	$dv/dt$	$T_j=125^\circ\text{C}$ , $V_D=2/3V_{DRM}$	500			V/ $\mu\text{s}$
ターンオフ時間 Turn-Off Time	$t_q$	$T_j=125^\circ\text{C}$ , $I_{TM}=I_o$ , $V_D=2/3V_{DRM}$ $dv/dt=20\text{V}/\mu\text{s}$ , $V_R=100\text{V}$ , $-di/dt=20\text{A}/\mu\text{s}$		100		$\mu\text{s}$
ターンオン時間 Turn-On Time	$t_{gt}$			6		$\mu\text{s}$
遅れ時間 Delay Time	$t_d$	$T_j=25^\circ\text{C}$ , $V_D=2/3V_{DRM}$ $I_G=300\text{mA}$ , $di_G/dt=0.2\text{A}/\mu\text{s}$		2		$\mu\text{s}$
立上がり時間 Rise Time	$t_r$			4		$\mu\text{s}$
ラッチング電流 Latching Current	$I_L$	$T_j=25^\circ\text{C}$		120		mA
保持電流 Holding Current	$I_H$	$T_j=25^\circ\text{C}$		80		mA
熱抵抗 Thermal Resistance	$R_{th(j-c)}$	接合部-ケース間 Junction to Case			0.25	$^\circ\text{C}/\text{W}$
接触熱抵抗 Thermal Resistance	$R_{th(c-f)}$	ケース-フィン間, サーマルコンパウンド塗布 Case to Fin, Greased			0.1	$^\circ\text{C}/\text{W}$

質量…約480g  
Approximate Weight

1 アーム当りの値 Value Per 1 Arm.

■定格・特性曲線

オン電圧特性  
ON-STATE CURRENT VS. VOLTAGE

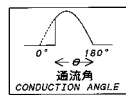
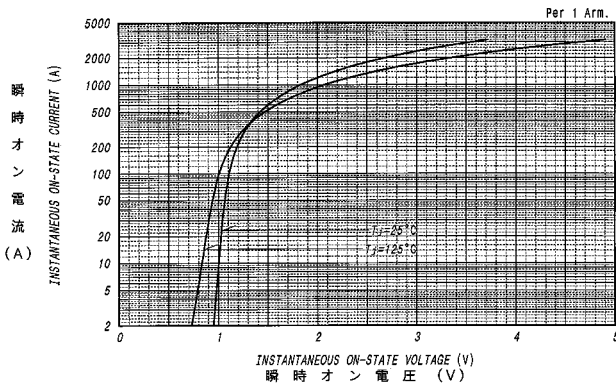

平均オン電力損失特性  
AVERAGE ON-STATE POWER DISSIPATION  
for SINUSOIDAL CURRENT WAVEFORM

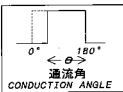
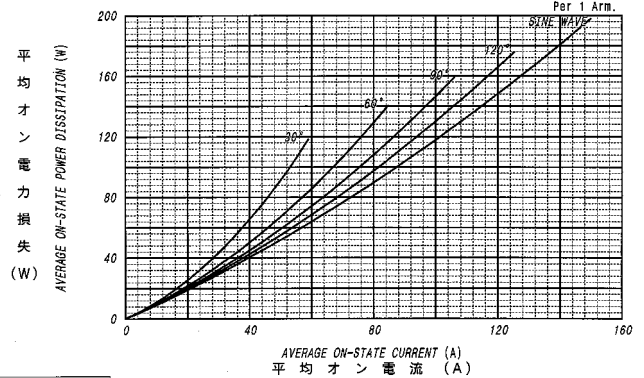

平均オン電力損失特性  
AVERAGE ON-STATE POWER DISSIPATION  
for RECTANGULAR CURRENT WAVEFORM

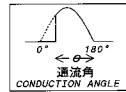
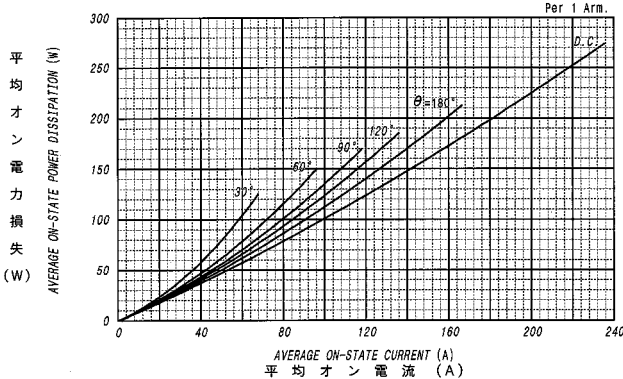

平均オン電流-ケース温度定格  
AVERAGE ON-STATE CURRENT VS. CASE TEMPERATURE

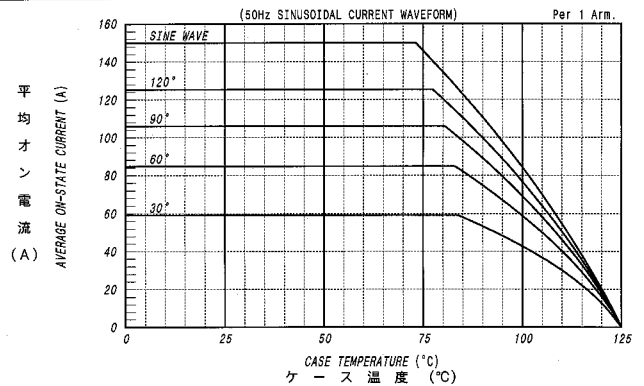

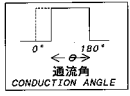

平均オン電流 - ケース温度定格  
AVERAGE ON-STATE CURRENT VS. CASE TEMPERATURE

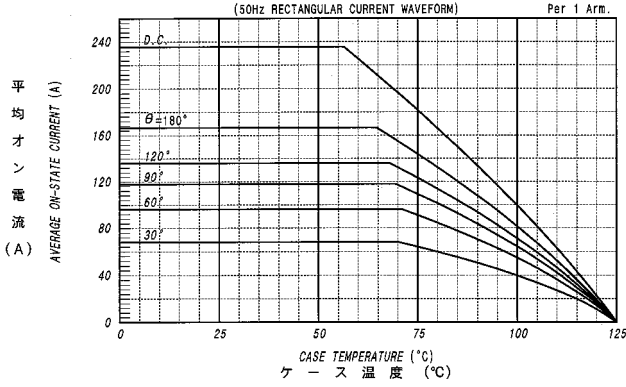

ゲート特性  
GATE CHARACTERISTICS

サージオン電流定格  
SURGE CURRENT RATINGS

f=50Hz, Half Sine Wave, Non-Repetitive, T<sub>j</sub>=125°C

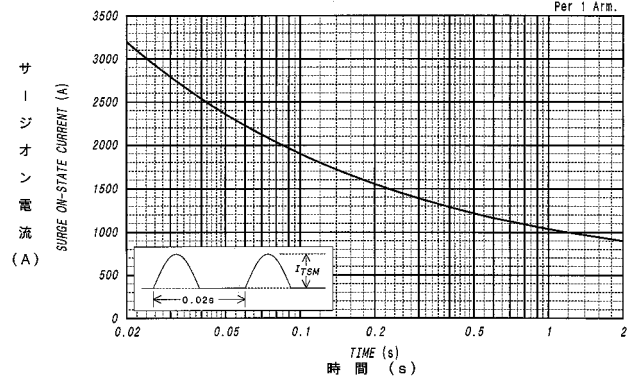

ゲート定格  
GATE RATINGS

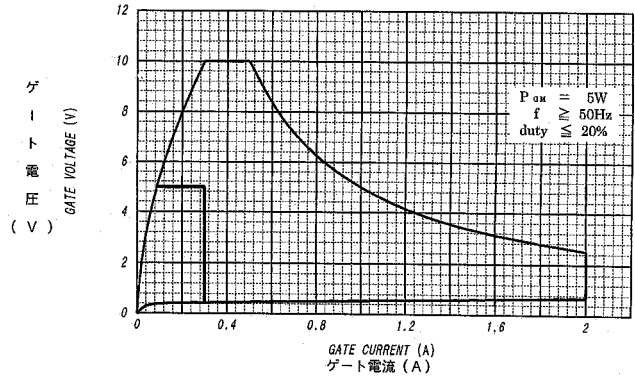
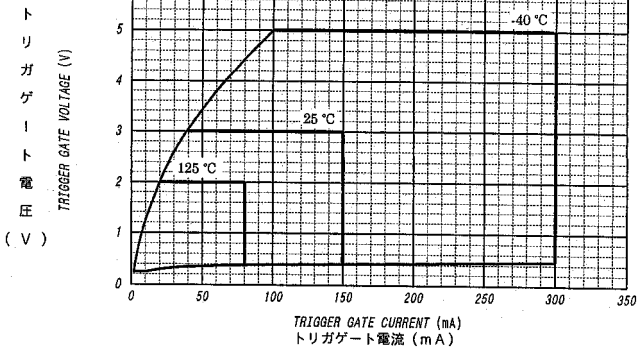

過渡熱抵抗特性  
MAXIMUM TRANSIENT THERMAL IMPEDANCE  
Junction to Case

