

# THYRISTOR

## 250A Avg 800 Volts

### PAH250N8

#### ■回路図 CIRCUIT

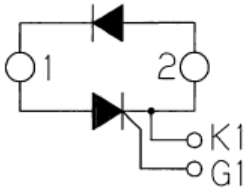

#### ■外形寸法図 OUTLINE DRAWING

Dimension: [mm]

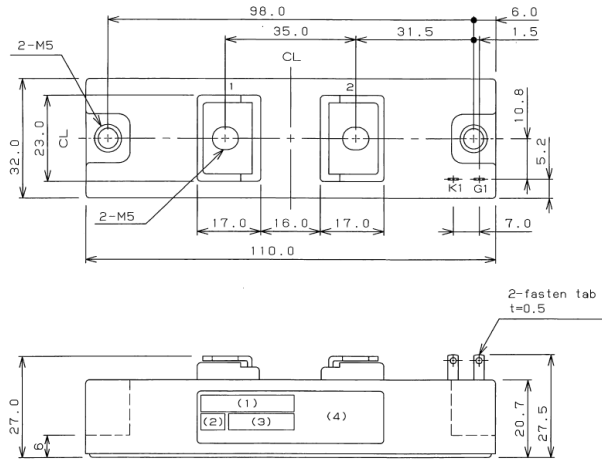

#### ■最大定格 Maximum Ratings

項目 Parameter	記号 Symbol	耐圧クラス Grade	単位 Unit
		PAH250N8	
くり返しピークオフ電圧 Repetitive Peak Off-State Voltage	$V_{DRM}$	800	V
非くり返しピークオフ電圧 Non Repetitive Peak Off-State Voltage	$V_{DSM}$	900	V

項目 Parameter	記号 Symbol	条件 Conditions	定格値 Max. Rated Value	単位 Unit	
平均整流電流 Average Rectified Output Current	$I_{O(AV)}$	DC 通電 $T_c=104^\circ\text{C}$	250	A	
サージオン電流 Surge On-State Current	$I_{TSM}$	50Hz 正弦半波, 1サクル, 非くり返し Half Sine Wave, 1Pulse, Non-Repetitive	5000	A	
電流二乗時間積 $I^2t$	$I^2t$	2~10ms	125000	$\text{A}^2 \text{s}$	
臨界オン電流上昇率 Critical Rate of Rise of Turned-On Current	$di/dt$	$V_D=2/3 V_{DRM}$ , $I_{TM}=2 \cdot I_O$ , $T_j=125^\circ\text{C}$ $I_G=200\text{mA}$ , $di/dt=0.2\text{A}/\mu\text{s}$	100	$\text{A}/\mu\text{s}$	
ピークゲート電力損失 Peak Gate Power	$P_{GM}$		5	W	
平均ゲート電力損失 Average Gate Power	$P_{G(AV)}$		1	W	
ピークゲート電流 Peak Gate Current	$I_{GM}$		2	A	
ピークゲート電圧 Peak Gate Voltage	$V_{GM}$		10	V	
ピークゲート逆電圧 Peak Gate Reverse Voltage	$V_{RGM}$		5	V	
動作接合温度範囲 Operating Junction Temperature Range	$T_{jw}$	125~150°Cはサイリスタ部に順・逆電圧を印加しないこと $T_j > 125^\circ\text{C}$ , Cannot be Biased for Thyristor	-40 ~ +150	$^\circ\text{C}$	
保存温度範囲 Storage Temperature Range	$T_{stg}$		-40 ~ +125	$^\circ\text{C}$	
絶縁耐圧 Isolation Voltage	$V_{iso}$	端子-ベース間, AC 1分間 Terminal to Base, AC 1min.	2500	V	
締付トルク Mounting Torque	ベース部 Mounting	サマルコパウト 塗布 Greased	M5	2.4 ~ 2.8	$\text{N} \cdot \text{m}$
	主端子部 Terminal		M5	2.4 ~ 2.8	$\text{N} \cdot \text{m}$

■電気的特性 Electrical Characteristics

項目 Parameter	記号 Symbol	条件 Conditions	特性値 (最大) Maximum Value			単位 Unit	
			最小 Min	標準 Typ	最大 Max		
ピークオフ電流 Peak Off-State Current	$I_{DM}$	$T_j = 125^\circ\text{C}$ , $V_{DM} = V_{DRM}$			80	mA	
ピークオン電圧 Peak Off-State Voltage	$V_{TM}$	$T_j = 25^\circ\text{C}$ , $I_{TM} = 750\text{A}$			1.55	V	
トリガゲート電流 Gate Current to Trigger	$I_{GT}$	$V_D = 6\text{V}$ , $I_T = 1\text{A}$	$T_j = -40^\circ\text{C}$		300	mA	
			$T_j = 25^\circ\text{C}$		150		
			$T_j = 125^\circ\text{C}$		80		
トリガゲート電圧 Gate Voltage to Trigger	$V_{GT}$	$V_D = 6\text{V}$ , $I_T = 1\text{A}$	$T_j = -40^\circ\text{C}$		5	V	
			$T_j = 25^\circ\text{C}$		3		
			$T_j = 125^\circ\text{C}$		2		
非トリガゲート電圧 Gate Non-Trigger Voltage	$V_{GD}$	$T_j = 125^\circ\text{C}$ , $V_D = 2/3 V_{DRM}$	0.25			V	
臨界オフ電圧上昇率 Critical Rate of Rise of Off-State Voltage	$dv/dt$	$T_j = 125^\circ\text{C}$ , $V_D = 2/3 V_{DRM}$	500			$\text{V}/\mu\text{s}$	
ターンオフ時間 Turn-Off Time	$t_q$	$T_j = 125^\circ\text{C}$ , $I_{TM} = I_o$ , $V_D = 2/3 V_{DRM}$ $dv/dt = 20\text{V}/\mu\text{s}$ , $V_R = 100\text{V}$ , $-di/dt = 20\text{A}/\mu\text{s}$		200		$\mu\text{s}$	
ターンオン時間 Turn-On Time	$t_{gt}$	$T_j = 25^\circ\text{C}$ , $V_D = 2/3 V_{DRM}$ $I_G = 200\text{mA}$ , $di/dt = 0.2\text{A}/\mu\text{s}$		6		$\mu\text{s}$	
遅れ時間 Delay Time	$t_d$			2		$\mu\text{s}$	
立ち上がり時間 Rise Time	$t_r$			4		$\mu\text{s}$	
ラッチング電流 Latching Current	$I_L$	$T_j = 25^\circ\text{C}$		150		mA	
保持電流 Holding Current	$I_H$	$T_j = 25^\circ\text{C}$		100		mA	
熱抵抗 Thermal Resistance	*1	$R_{th(j-c)}$	接合部-ケース間 (Tc 測定点: チップ直下) Junction to Case			0.08	$^\circ\text{C}/\text{W}$
接触熱抵抗 Thermal Resistance	*1	$R_{th(c-f)}$	ケースフィン間, サーマロンパワート塗布 Case to Fin, Greased			0.2	$^\circ\text{C}/\text{W}$

質量 ---- 約200 g  
Approximate Weight

\*1: 1アーム当りの値 Value Per 1 Arm.

オン電圧特性  
ON-STATE CURRENT VS. VOLTAGE

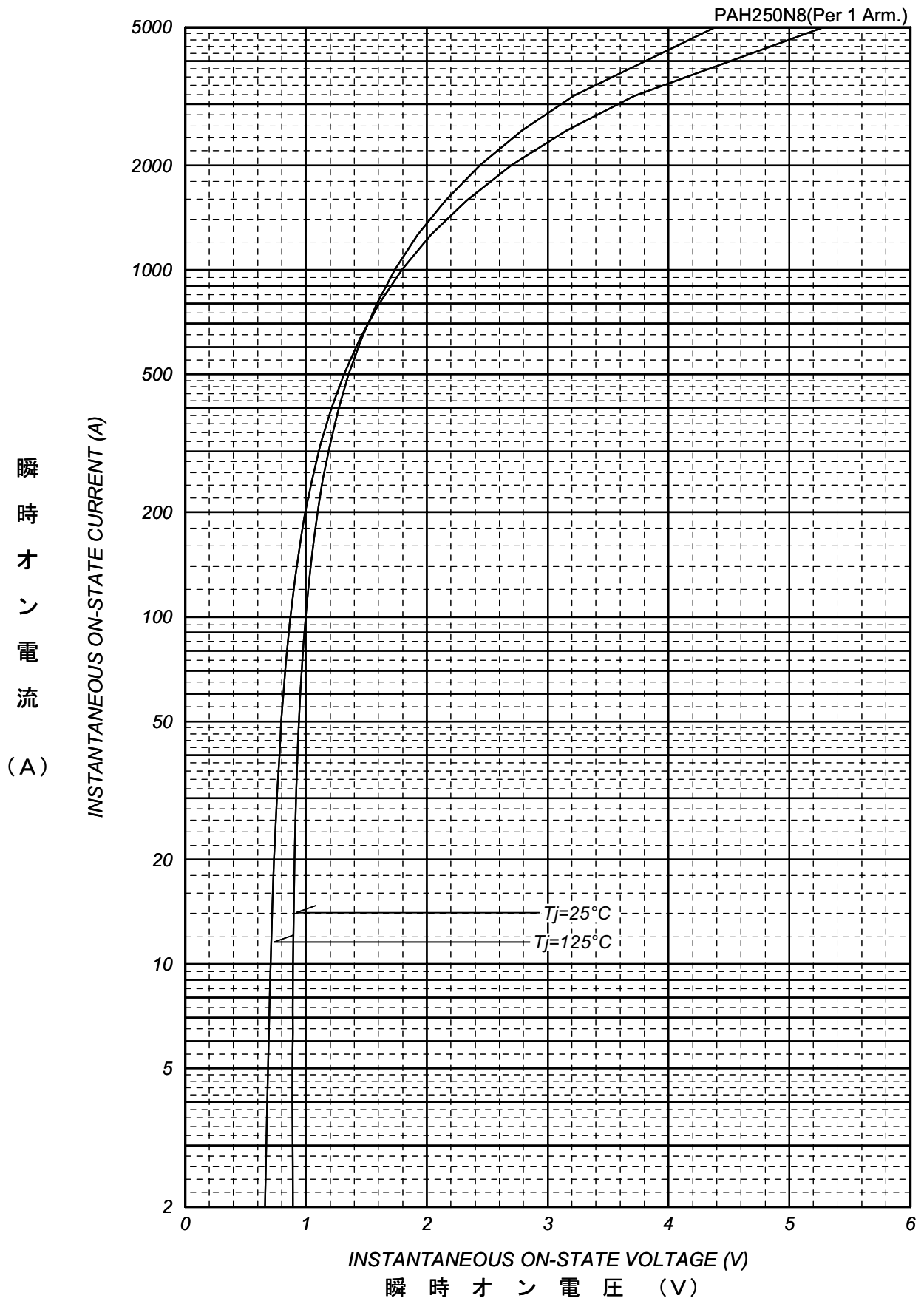

平均オン電力損失特性  
AVERAGE ON-STATE POWER DISSIPATION

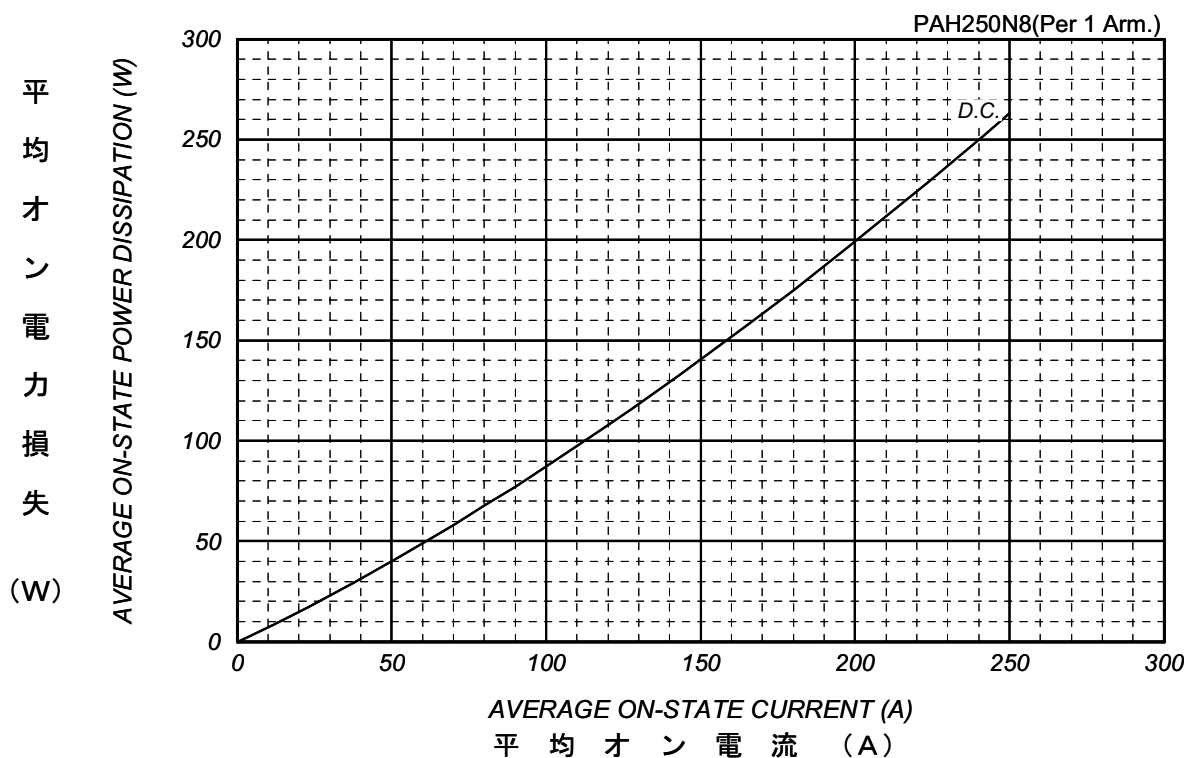

平均順電流 - ケース温度定格  
AVERAGE FORWARD CURRENT VS. CASE TEMPERATURE

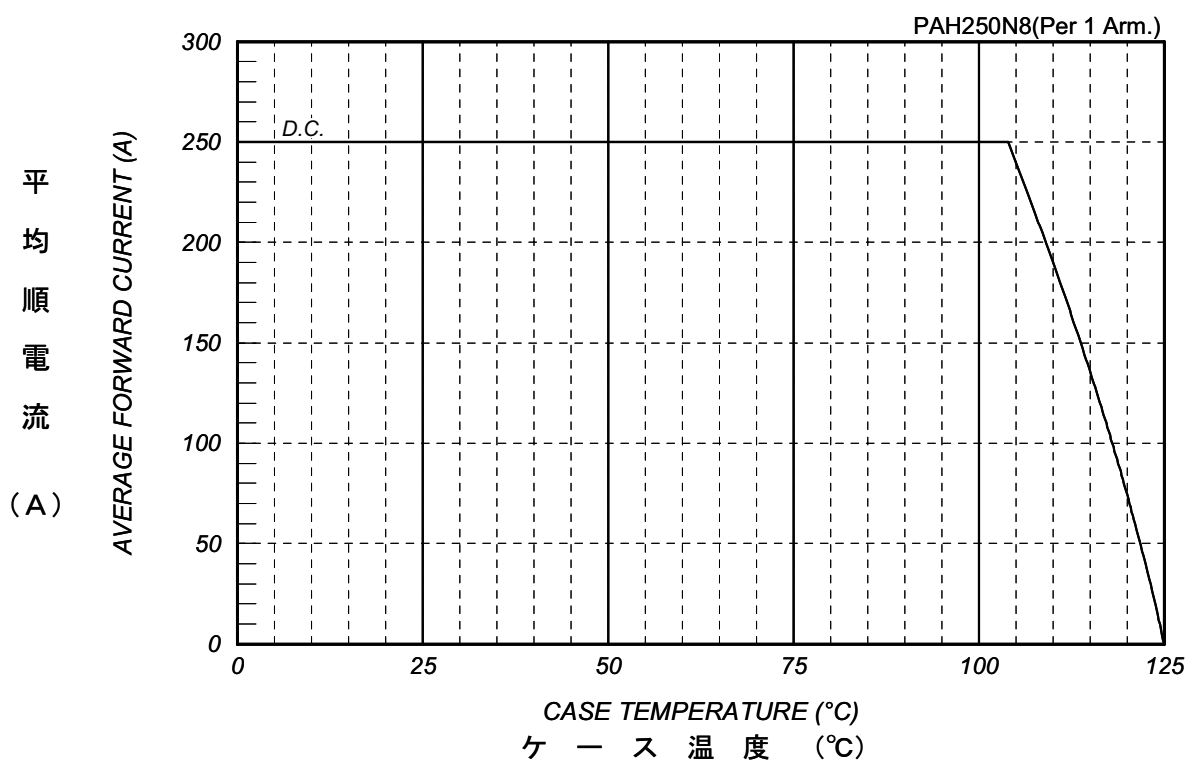

ゲート特性  
GATE CHARACTERISTICS

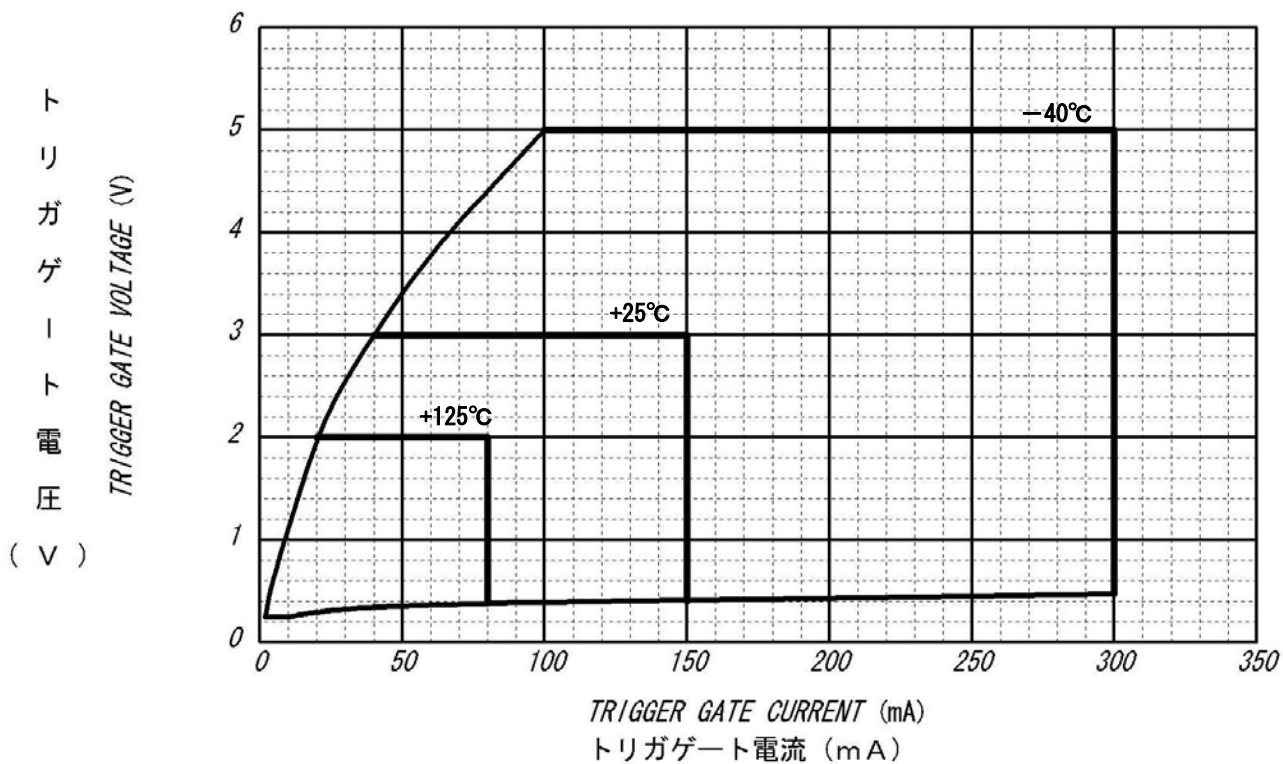

ゲート定格  
GATE RATINGS

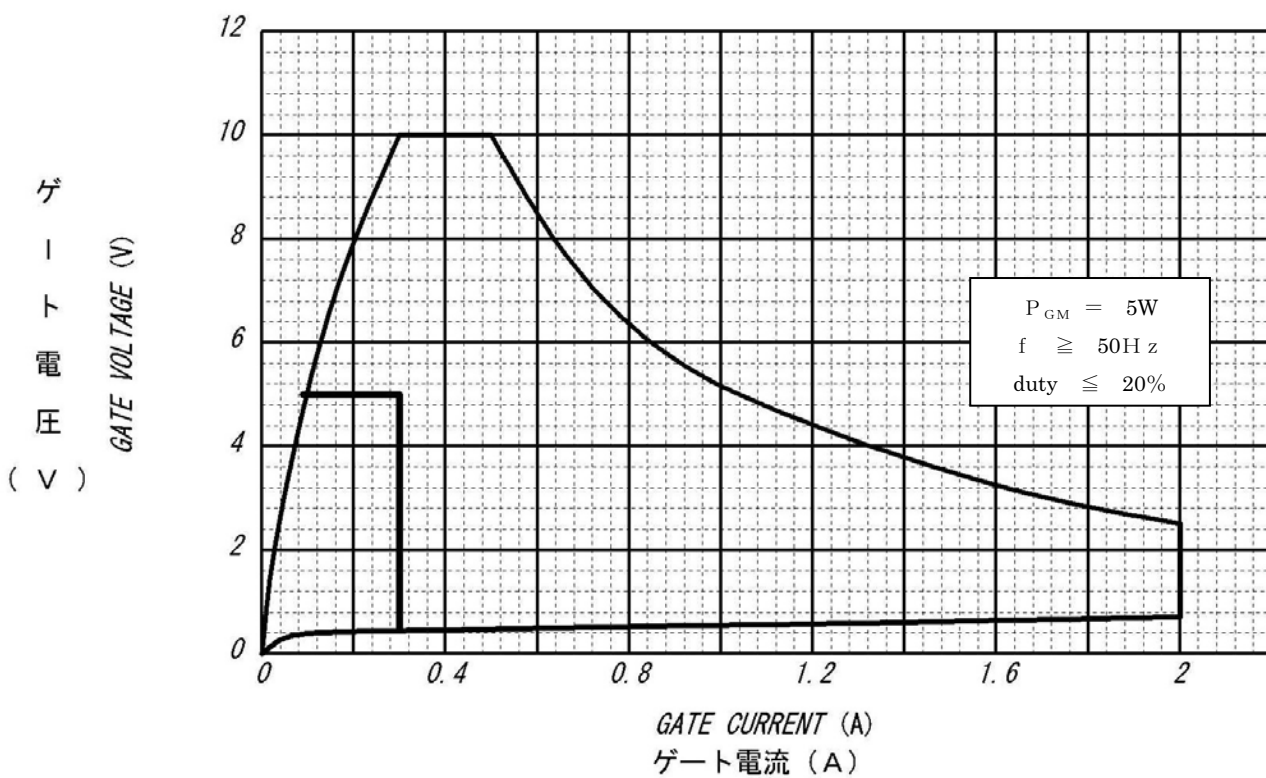

サージオン電流定格  
SURGE CURRENT RATINGS

f=50Hz, Half Sine Wave, Non-Repetitive, On Load

PAH250N8(Per 1 Arm.)

サ  
ー  
ジ  
オ  
ン  
電  
流  
  
(A)

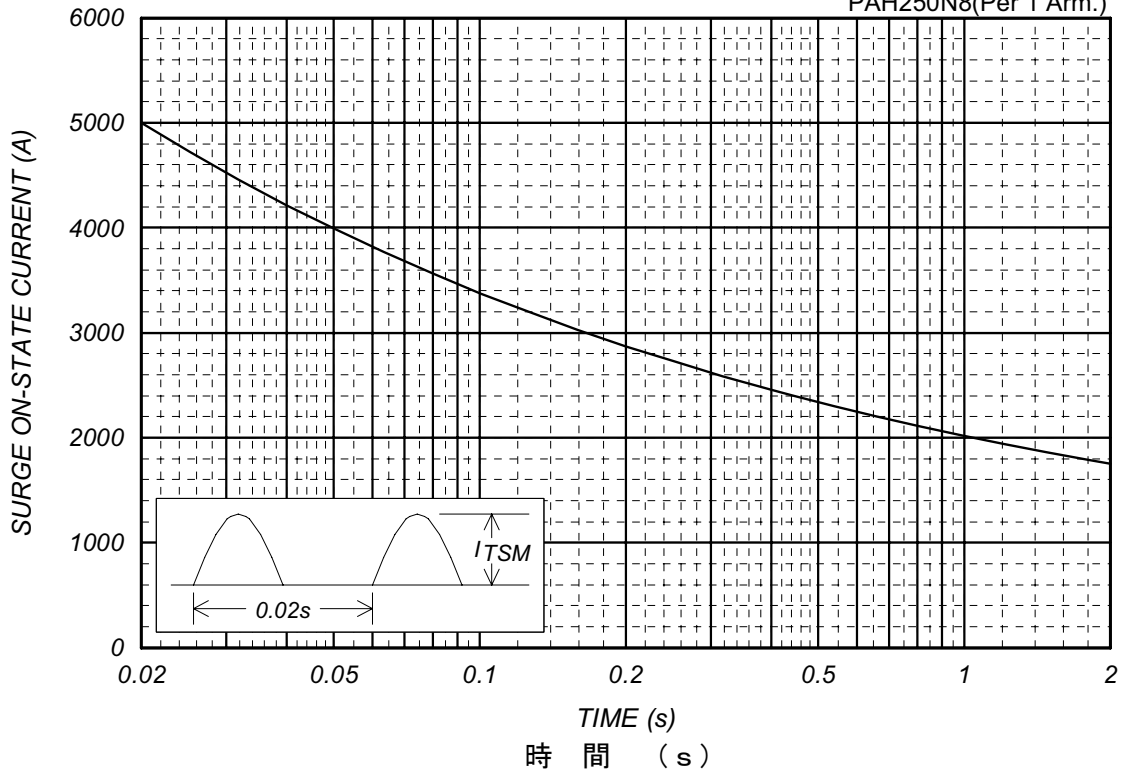

過渡熱抵抗特性  
Transient Thermal Impedance

PAH250N8(Per 1 Arm.)

過  
渡  
熱  
抵  
抗  
  
(°C/W)

