

THYRISTOR

66A RMS 800 Volts

PAT308
PAH308

回路図 CIRCUIT

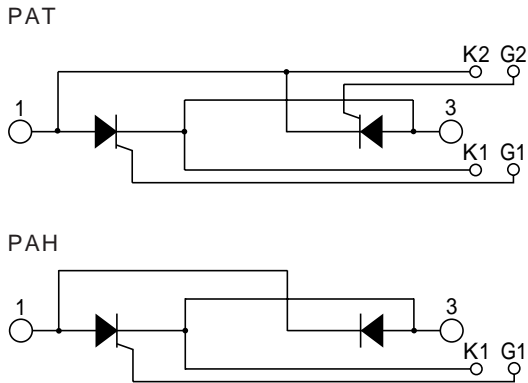

外形寸法図 OUTLINE DRAWING

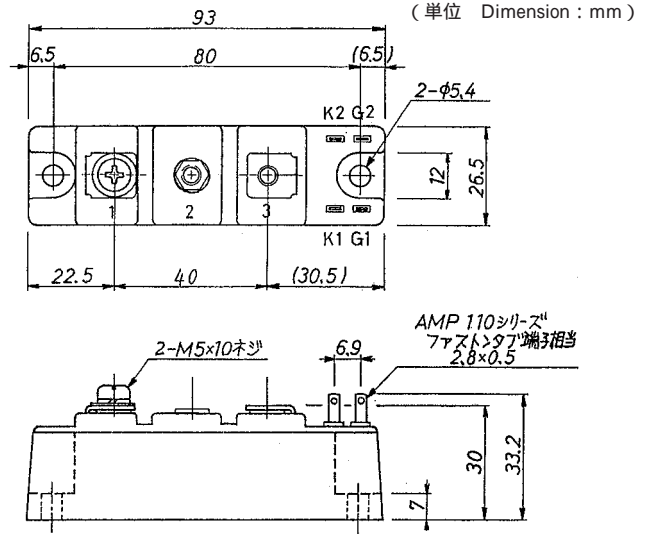

最大定格 Maximum Ratings

項目 Parameter	記号 Symbol	耐压クラス Grade	単位 Unit
		PAT308/PAH308	
くり返しピークオフ電圧 Repetitive Peak Off-State Voltage	V_{DRM}	800	V
非くり返しピークオフ電圧 Non Repetitive Peak Off-State Voltage	V_{DSM}	960	V

項目 Parameter	記号 Symbol	条件 Conditions	定格値 Max. Rated Value	単位 Unit		
実効オン電流 RMS On-State Current	$I_{T(RMS)}$	商用周波数 180° 通電 $T_c = 95$ Half Sine Wave	66	A		
サージオン電流 Surge On-State Current	I_{TSM}	50Hz正弦半波, 1 サイクル, 非くり返し Half Sine Wave, 1Pulse, Non-Repetitive	600	A		
電流二乗時間積 I Squared t	I^2t	2 ~ 10ms	1800	A^2s		
臨界オン電流上昇率 Critical Rate of Rise of Turned-On Current	di/dt	$V_D = 2/3V_{DRM}$, $I_{TM} = I_{T(RMS)}$, $T_j = 125$ $I_G = 200mA$, $di_G/dt = 0.2A/\mu s$	100	$A/\mu s$		
ピークゲート電力損失 Peak Gate Power	P_{GM}		5	W		
平均ゲート電力損失 Average Gate Power	$P_{G(AV)}$		1	W		
ピークゲート電流 Peak Gate Current	I_{GM}		2	A		
ピークゲート電圧 Peak Gate Voltage	V_{GM}		10	V		
ピークゲート逆電圧 Peak Gate Reverse Voltage	V_{RGM}		5	V		
動作接合温度範囲 Operating Junction Temperature Range	T_{jw}		- 40 ~ + 125			
保存温度範囲 Storage Temperature Range	T_{stg}		- 40 ~ + 125			
絶縁耐圧 Isolation Voltage	V_{iso}	端子 - ベース間, AC 1 分間 Terminal to Base, AC 1 min.	2000	V		
締付トルク Mounting Torque	ベース部 Mounting	F	サーマルコンパウンド塗布 Greased	M5	2.4 ~ 2.8	N·m
	主端子部 Terminal			M5	2.4 ~ 2.8	N·m

1 アーム当りの値 Value Per 1 Arm.

電気的特性 Electrical Characteristics

項目 Parameter	記号 Symbol	条件 Conditions	特性値(最大) Maximum Value			単位 Unit
			最小 Min.	標準 Typ.	最大 Max.	
ピークオフ電流 Peak Off-State Current	I_{DM}	$T_j=125$, $V_{DM}=V_{DRM}$			20	mA
ピークオン電圧 Peak On-State Voltage	V_{TM}	$T_j=25$, $I_{TM}=90A$			1.45	V
トリガゲート電流 Gate Current to Trigger	I_{GT}	$V_D=6V$, $I_T=1A$	$T_j= - 40$		200	mA
			$T_j= 25$		100	mA
			$T_j= 125$		50	mA
トリガゲート電圧 Gate Voltage to Trigger	V_{GT}	$V_D=6V$, $I_T=1A$	$T_j= - 40$		4	V
			$T_j= 25$		2.5	V
			$T_j= 125$		2	V
非トリガゲート電圧 Gate Non-Trigger Voltage	V_{GD}	$T_j=125$, $V_D=2/3V_{DRM}$	0.25			V
臨界オフ電圧上昇率 Critical Rate of Rise of Off-State Voltage	dv/dt	$T_j=125$, $V_D=2/3V_{DRM}$	500			V/ μ s
ターンオフ時間 Turn-Off Time	t_q	$T_j=125$, $I_{TM}=I_{T(RMS)}$, $V_D=2/3V_{DRM}$ dv/dt=20V/ μ s , $V_R=100V$, - di/dt=20A/ μ s		100		μ s
ターンオン時間 Turn-On Time	t_{gt}	$T_j=25$, $I_{TM}=I_{T(RMS)}$, $V_D=100V$ $I_G=200mA$, dig/dt=0.2A/ μ s		6		μ s
遅れ時間 Delay Time	t_d			2		μ s
立上がり時間 Rise Time	t_r			4		μ s
ラッチング電流 Latching Current	I_L	$T_j=25$		100		mA
保持電流 Holding Current	I_H	$T_j=25$		50		mA
熱抵抗 Thermal Resistance	*1 $R_{th(j-c)}$	接合部 - ケース間 (トータル) Junction to Case, Total			0.35	/W
接触熱抵抗 Thermal Resistance	*1 $R_{th(c-f)}$	ケース - フィン間 (トータル), サーマルコンパウンド塗布 Case to Fin, Total, Greased			0.1	/W

質量...約155g
Approximate Weight

1 アーム当りの値 Value Per 1 Arm.
*1 : 1 モジュール当りの値 Value Per Module.

オン電圧特性
ON-STATE CURRENT VS. VOLTAGE

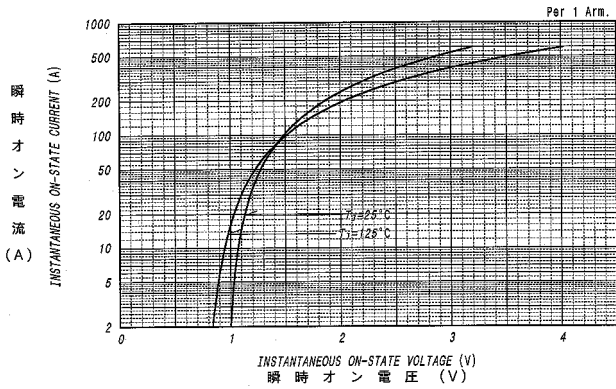

サージオン電流定格
SURGE CURRENT RATINGS

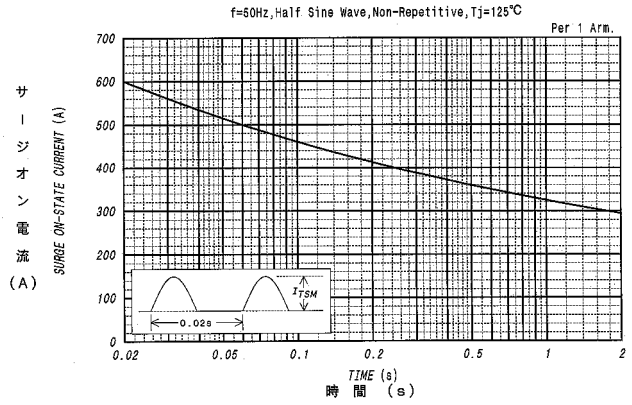

平均オン電力損失特性
AVERAGE ON-STATE POWER DISSIPATION

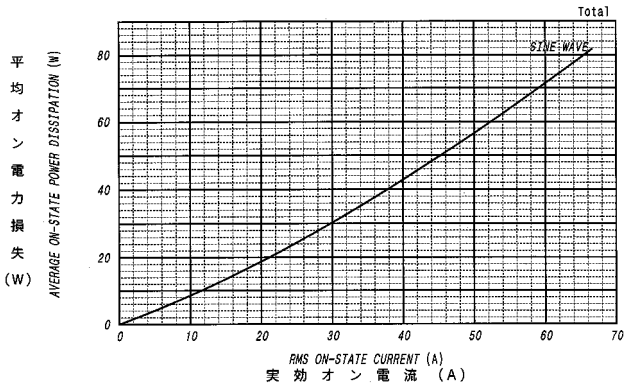

実効オン電流-ケース温度定格
RMS ON-STATE CURRENT VS. CASE TEMPERATURE

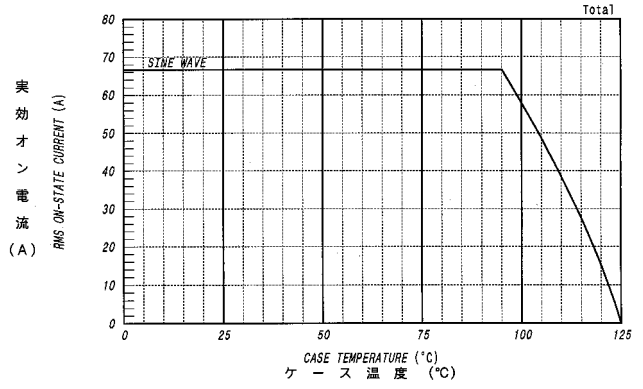

ゲート特性
GATE CHARACTERISTICS

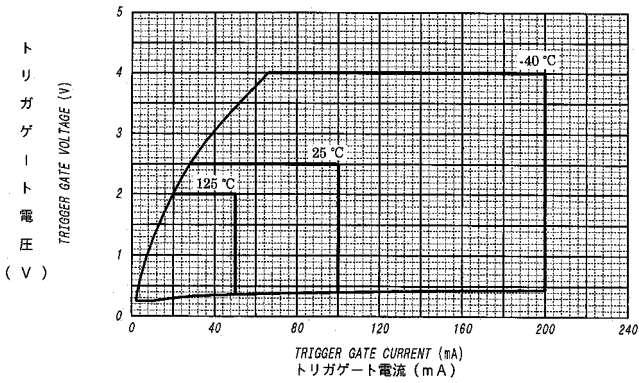

ゲート定格
GATE RATINGS

