

FRD

200A Avg 600 Volts

PC201FKN6

■回路図 CIRCUIT

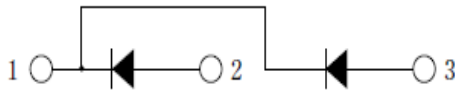

■外形寸法図 OUTLINE DRAWING

Dimension: [mm]

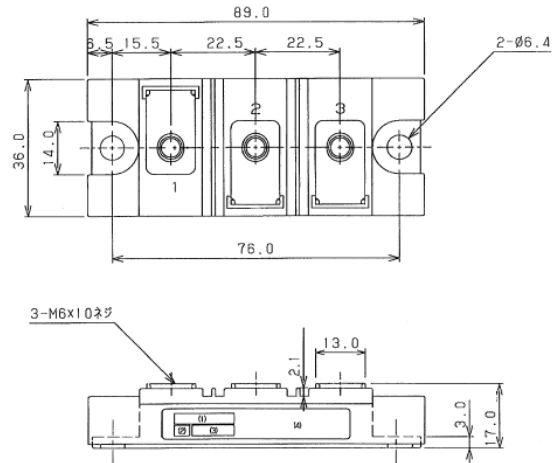

■最大定格 Maximum Ratings

項目 Parameter	記号 Symbol	耐圧クラス Grade		単位 Unit
		PC201FKN6		
くり返しピーク逆電圧 Repetitive Peak Reverse Voltage	*1 $V_{RRM}$	600		V
非くり返しピーク逆電圧 Non Repetitive Peak Reverse Voltage	*1 $V_{RSM}$	—		V

項目 Parameter	記号 Symbol	条件 Conditions	定格値 Max.Rated Value	単位 Unit		
平均整流電流 Average Rectified Output Current	*1 $I_{O(AV)}$	商用周波数 180° 通電 $T_c=105^\circ\text{C}$ Half Sine Wave	200	A		
実効順電流 RMS Forward Current	*1 $I_{FRMS}$		314	A		
サージ順電流 Surge Forward Current	*1 $I_{FSM}$	50Hz 正弦半波, 1サイクル, 非くり返し Half Sine Wave, 1Pulse, Non-Repetitive	2000	A		
電流二乗時間積 I Squared t	*1 $I^2t$	2~10ms	20000	A <sup>2</sup> s		
動作接合温度範囲 Operating Junction Temperature Range	$T_{jw}$		-40 ~ +150	°C		
保存温度範囲 Storage Temperature Range	$T_{stg}$		-40 ~ +125	°C		
絶縁耐圧 Isolation Voltage	$V_{iso}$	端子—ベース間, AC 1分間 Terminal to Base, AC 1min	2500	V		
締付トルク Mounting Torque	ベース部 Mounting	F	サマルコパウト <sup>®</sup> 塗布 Greased	M6	2.5 ~ 3.5	N・m
	主端子部 Terminal		M6	2.5 ~ 3.5	N・m	

■電気的特性 Electrical Characteristics

項目 Parameter	記号 Symbol	条件 Conditions	特性値 (最大) Maximum Value	単位 Unit
ピーク逆電流 Peak Reverse Current	*1 $I_{RM}$	$T_j=150^\circ\text{C}$ , $V_{RM}=V_{RRM}$	10	mA
ピーク順電圧 Peak Forward Voltage	*1 $V_{FM}$	$T_j=25^\circ\text{C}$ , $I_{FM}=200\text{A}$	1.40	V
逆回復時間 Reverse Recovery Time	*1 $t_{rr}$	$T_j=25^\circ\text{C}$ , $I_{FM}=10\text{A}$ , $-di/dt=50\text{A}/\mu\text{s}$	110	ns
熱抵抗 Thermal Resistance	*1 $R_{th(j-c)}$	接合部—ケース間 Junction to Case	0.15	°CW
接触熱抵抗 Thermal Resistance	$R_{th(c-f)}$	ケースフィン間, サマルコパウト <sup>®</sup> 塗布 Case to Fin, Greased	0.1	°CW

質量 --- 約 150g  
Approximate Weight

\*1: 1アーム当りの値 Value Per 1 Arm.

順電圧特性  
FORWARD CURRENT VS. VOLTAGE

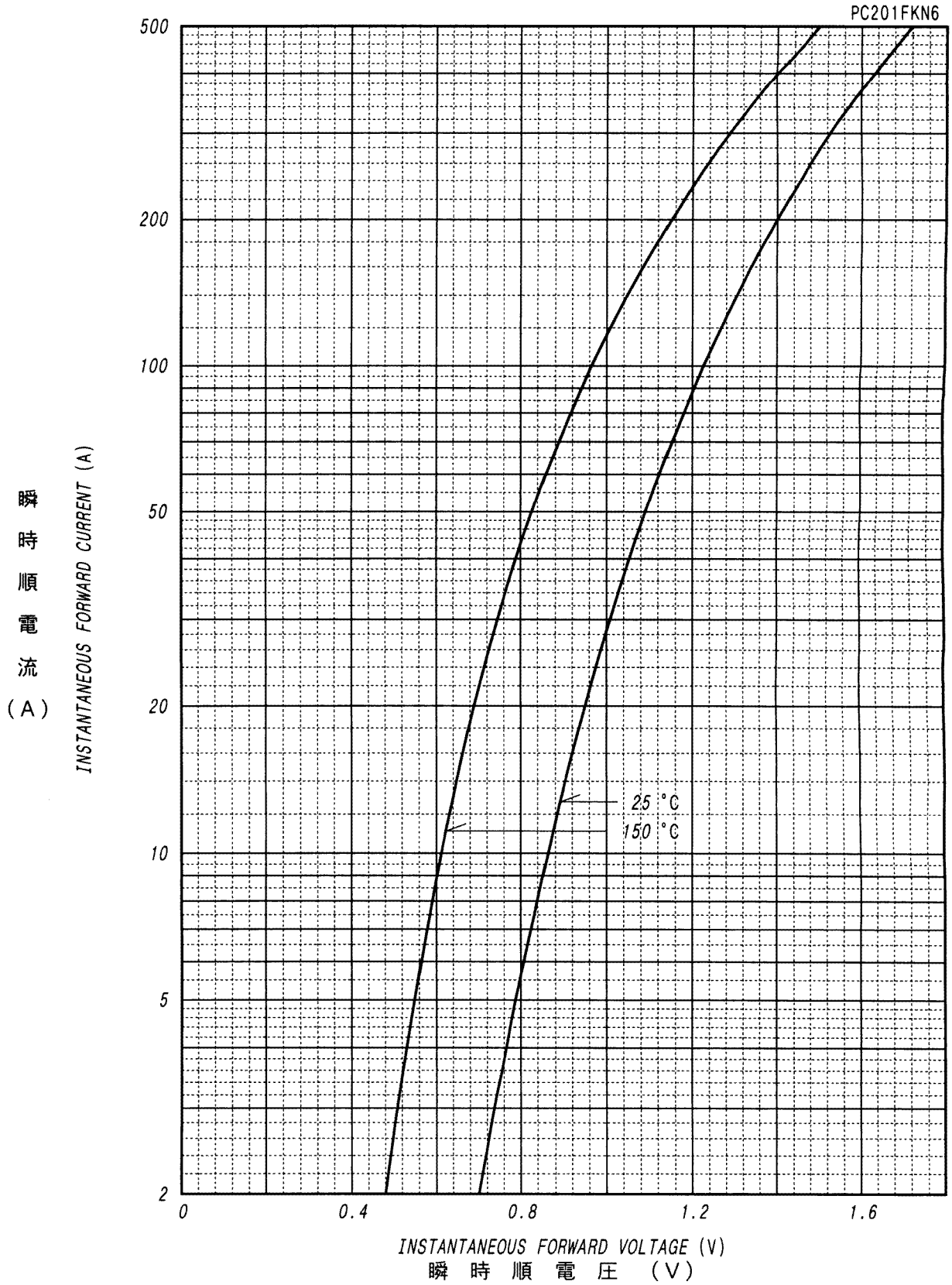

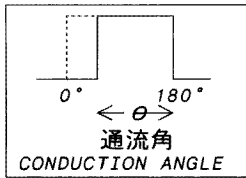

平均順電力損失特性  
 AVERAGE FORWARD POWER DISSIPATION

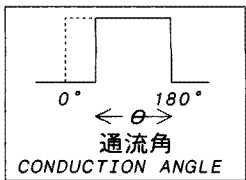
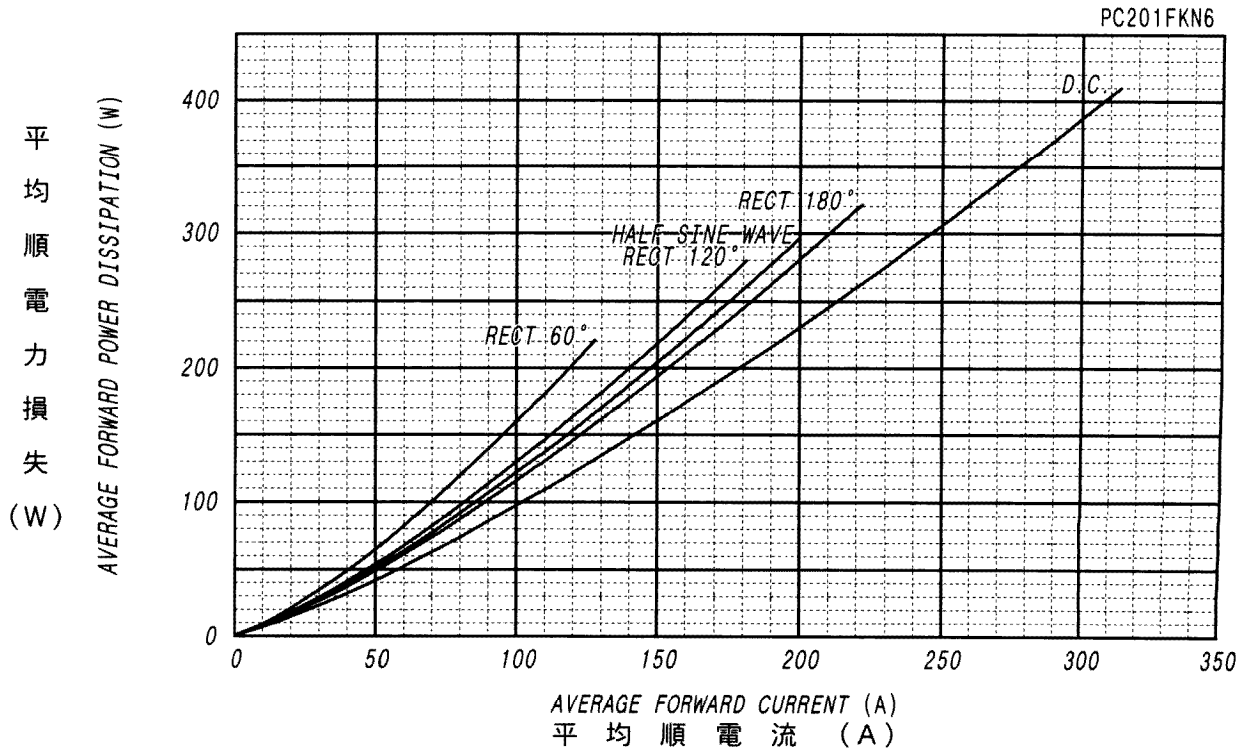

平均順電流 - ケース温度定格  
 AVERAGE FORWARD CURRENT VS. CASE TEMPERATURE

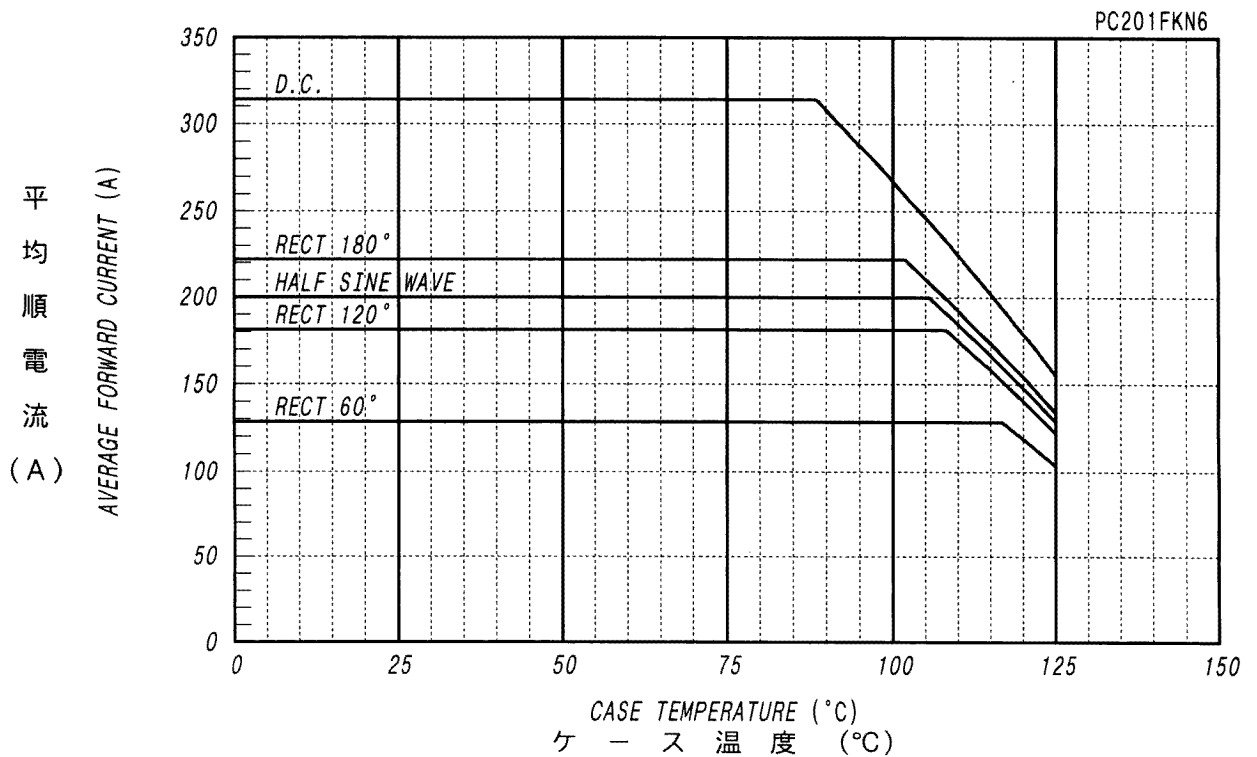

サージ順電流定格  
SURGE CURRENT RATINGS

f=50Hz, Half Sine Wave, Non-Repetitive, Tj=150°C

PC201FKN6

サ  
ー  
ジ  
順  
電  
流  
(A)

