

DIODE

250A Avg 800 Volts

PC2508
PD2508

■回路図 CIRCUIT

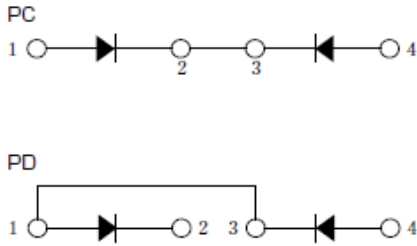

■外形寸法図 OUTLINE DRAWING

Dimension: [mm]

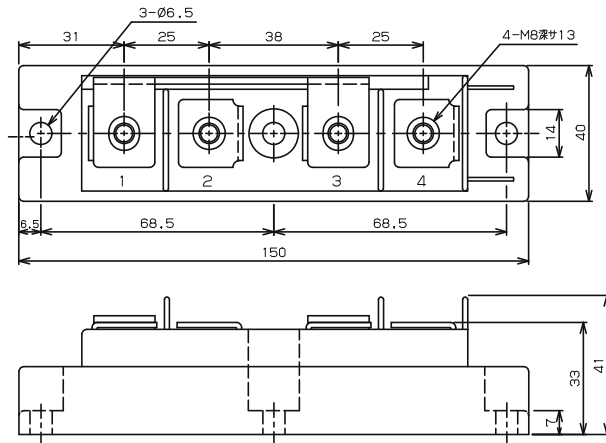

■最大定格 Maximum Ratings

| 項目 Parameter | 記号 Symbol | 耐圧クラス Grade | | 単位 Unit |
|--|------------------------|---------------|--|------------|
| | | PC2508/PD2508 | | |
| くり返しピーク逆電圧 Repetitive Peak Reverse Voltage | *1 V _{RRM} | 800 | | V |
| 非くり返しピーク逆電圧 Non Repetitive Peak Reverse Voltage | *1 V _{RSM} | 900 | | V |

| 項目 Parameter | 記号 Symbol | 条件 Conditions | 定格値 Max.Rated Value | 単位 Unit | | |
|--|---------------------------|---|-----------------------------|------------------|------------|-----|
| 平均整流電流 Average Rectified Output Current | *1 I _{O(AV)} | 商用周波数 180° 通電 Half Sine Wave | T _c =95°C 250 | A | | |
| 実効順電流 RMS Forward Current | *1 I _{F(RMS)} | | 390 | A | | |
| サージ順電流 Surge Forward Current | *1 I _{FSM} | 50Hz 正弦半波, 1サイクル, 非くり返し Half Sine Wave, 1Pulse, Non-Repetitive | 5000 | A | | |
| 電流二乗時間積 I Squared t | *1 I ² t | 2~10ms | 125000 | A ² s | | |
| 動作接合温度範囲 Operating Junction Temperature Range | T _{jw} | | -40 ~ +150 | °C | | |
| 保存温度範囲 Storage Temperature Range | T _{stg} | | -40 ~ +125 | °C | | |
| 絶縁耐圧 Isolation Voltage | V _{iso} | 端子-ベース間, AC 1分間 Terminal to Base, AC 1min. | 2000 | V | | |
| 締付トルク Mounting Torque | ベース部 Mounting | F | サマルコパ ウッド 塗布 Greased | M6 | 2.5 ~ 3.5 | N・m |
| | 主端子部 Terminal | | | M8 | 9.0 ~ 10.0 | N・m |

■電気的特性 Electrical Characteristics

| 項目 Parameter | 記号 Symbol | 条件 Conditions | 特性値(最大) Maximum Value | 単位 Unit |
|--------------------------------|----------------------------|--|--------------------------|------------|
| ピーク逆電流 Peak Reverse Current | *1 I _{RM} | T _j =150°C, V _{RM} =V _{RRM} | 40 | mA |
| ピーク順電圧 Peak Forward Voltage | *1 V _{FM} | T _j = 25°C, I _{FM} =800A | 1.22 | V |
| 熱抵抗 Thermal Resistance | *1 R _{th(j-c)} | 接合部-ケース間 Junction to Case | 0.2 | °CW |
| 接触熱抵抗 Thermal Resistance | *1 R _{th(c-f)} | ケースフィン間, サマルコパ ウッド 塗布 Case to Fin, Greased | 0.1 | °CW |

質量 --- 約 530g
Approximate Weight

*1: 1アーム当りの値 Value Per 1 Arm.

■ 定格・特性曲線

順電圧特性
FORWARD CURRENT VS. VOLTAGE

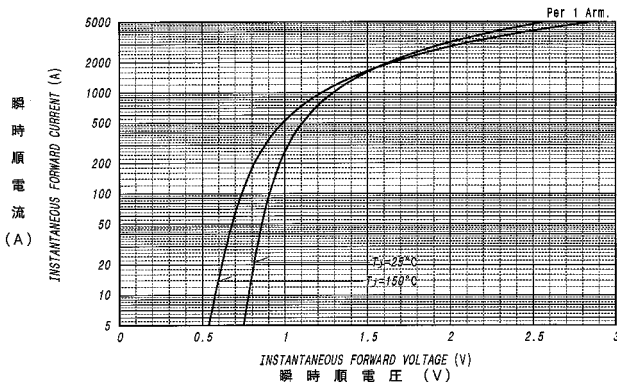

平均順電力損失特性
AVERAGE FORWARD POWER DISSIPATION

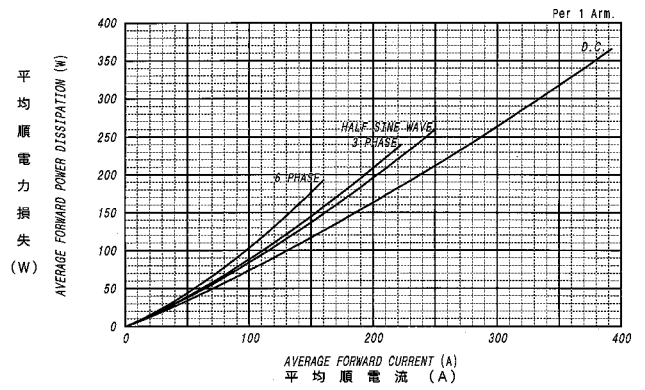

平均順電流 - ケース温度定格
AVERAGE FORWARD CURRENT VS. CASE TEMPERATURE

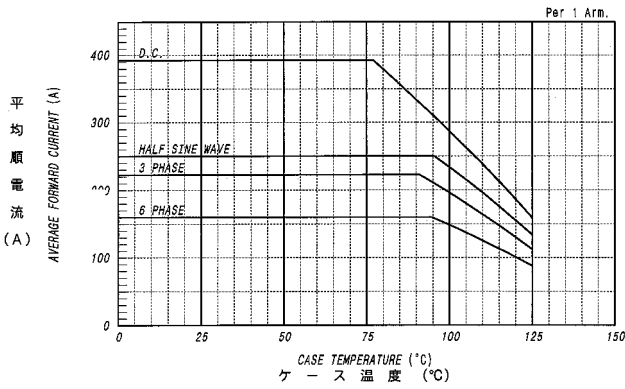

サージ順電流定格
SURGE CURRENT RATINGS

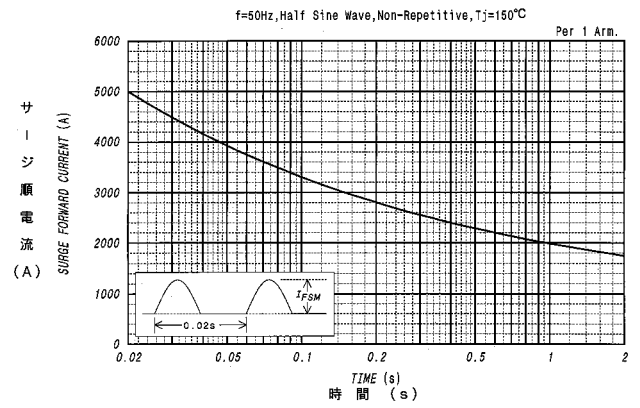

過渡熱抵抗特性
MAXIMUM TRANSIENT THERMAL IMPEDANCE
Junction to Case

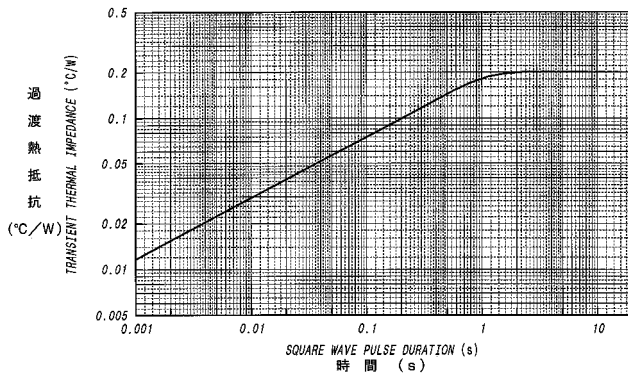

タイオーポジション