

DIODE

400A Avg 800 Volts

**PC4008
PD4008**

■回路図 CIRCUIT

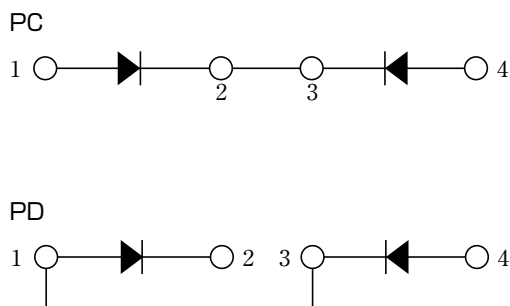

■外形寸法図 OUTLINE DRAWING

(単位 Dimension : mm)

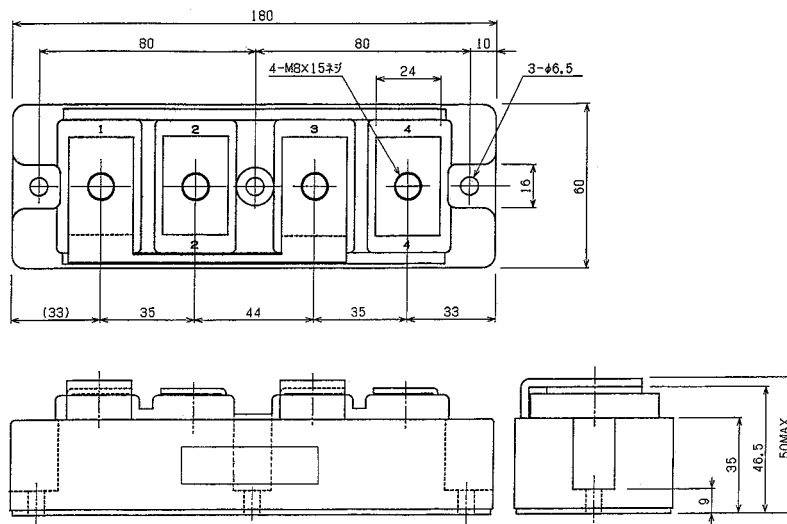

■最大定格 Maximum Ratings

項目 Parameter	記号 Symbol	耐压クラス Grade		単位 Unit
		PC4008/PD4008		
くり返しピーク逆電圧 *1 Repetitive Peak Reverse Voltage	V_{RRM}	800		V
非くり返しピーク逆電圧 *1 Non Repetitive Peak Reverse Voltage	V_{RSM}	900		V

項目 Parameter	記号 Symbol	条件 Conditions	定格値 Max. Rated Value	単位 Unit		
平均整流電流 *1 Average Rectified Output Current	$I_0(AV)$	商用周波数 180° 通電 $T_c = 94^\circ C$ Half Sine Wave	400	A		
実効順電流 *1 RMS Forward Current	$I_{F(RMS)}$		630	A		
サージ順電流 *1 Surge Forward Current	I_{FSM}	50Hz正弦半波, 1 サイクル, 非くり返し Half Sine Wave, 1Pulse, Non-Repetitive	8000	A		
電流二乗時間積 *1 I Squared t	I^2t	2 ~ 10ms	320000	A^2s		
動作接合温度範囲 Operating Junction Temperature Range	T_{jw}		- 40 ~ + 150	$^\circ C$		
保存温度範囲 Storage Temperature Range	T_{stg}		- 40 ~ + 125	$^\circ C$		
絶縁耐圧 Isolation Voltage	V_{iso}	端子-ベース間, AC 1 分間 Terminal to Base, AC 1 min.	2000	V		
締付トルク Mounting Torque	ベース部 Mounting 主端子部 Terminal	F	サーマルコンパウンド塗布 Greased	M6	2.5 ~ 3.5	N·m
				M8	9.0 ~ 10.0	N·m

■電気的特性 Electrical Characteristics

項目 Parameter	記号 Symbol	条件 Conditions	特性値 (最大) Maximum Value	単位 Unit
ピーク逆電流 *1 Peak Reverse Current	I_{RM}	$T_j = 150^\circ C, V_{RM} = V_{RRM}$	30	mA
ピーク順電圧 *1 Peak Forward Voltage	V_{FM}	$T_j = 25^\circ C, I_{FM} = 1300A$	1.25	V
熱抵抗 Thermal Resistance	$R_{th(j-c)}$	接合部-ケース間 Junction to Case	0.12	$^\circ C/W$
接触熱抵抗 Thermal Resistance	$R_{th(c-f)}$	ケース-フィン間, サーマルコンパウンド塗布 Case to Fin, Greased	0.05	$^\circ C/W$

質量…約1300g
Approximate Weight

*1 : 1 アーム当りの値 Value Per 1 Arm.

■ 定格・特性曲線

順電圧特性
FORWARD CURRENT VS. VOLTAGE

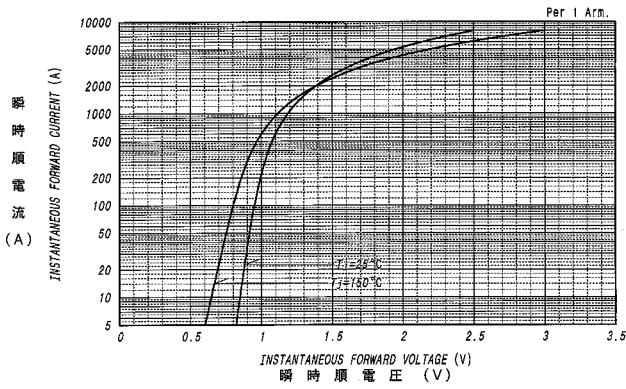

平均順電力損失特性
AVERAGE FORWARD POWER DISSIPATION

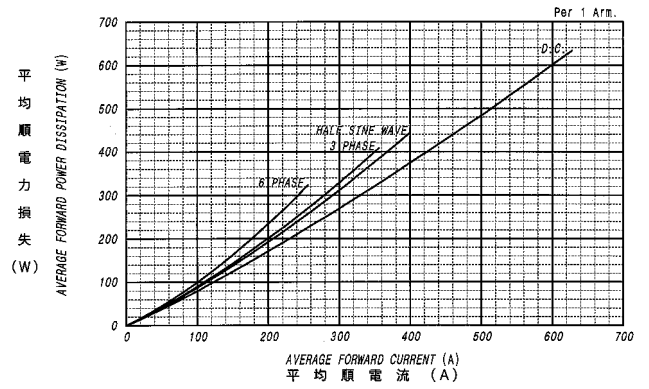

平均順電流 - ケース温度定格
AVERAGE FORWARD CURRENT VS. CASE TEMPERATURE

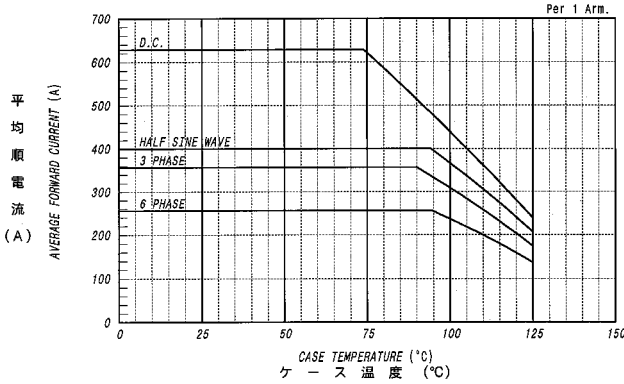

サージ順電流定格
SURGE CURRENT RATINGS

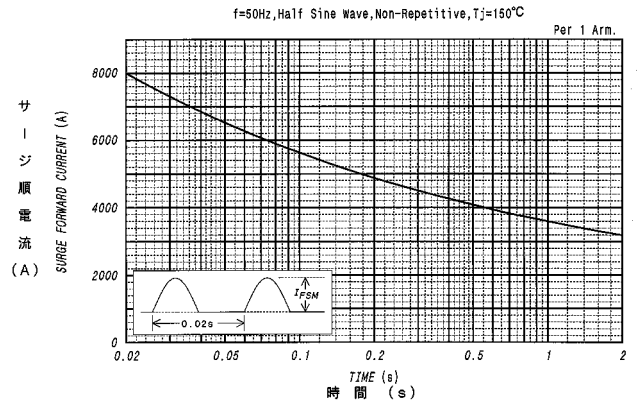

過渡熱抵抗特性
MAXIMUM TRANSIENT THERMAL IMPEDANCE
Junction to Case

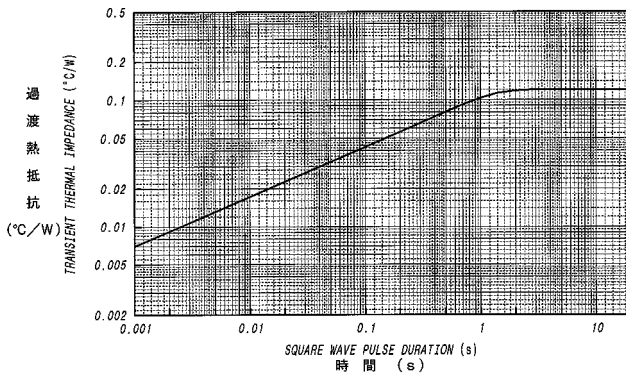

ダイオードモジュール