

□ 回路図 : *CIRCUIT*

□ 外形寸法図 : *OUTLINE DRAWING*

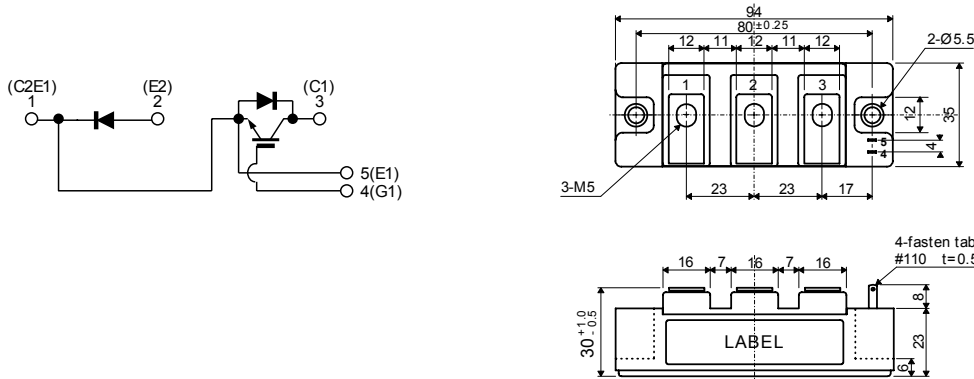

Dimension: [mm]

□ 最大定格 : *MAXIMUM RATINGS* ($T_c = 25^\circ\text{C}$)

Item	Symbol	Rated Value	Unit
コレクタ・エミッタ間電圧 Collector-Emitter Voltage	V_{CES}	600	V
ゲート・エミッタ間電圧 Gate-Emitter Voltage	V_{GES}	± 20	V
コレクタ電流 Collector Current	DC	75	A
	1ms	150	
コレクタ損失 Collector Power Dissipation	P_C	320	W
接合温度 Junction Temperature Range	T_j	$-40 \sim +150$	$^\circ\text{C}$
保存温度 Storage Temperature Range	T_{stg}	$-40 \sim +125$	$^\circ\text{C}$
絶縁耐圧(Terminal to Base AC, 1 minute) Isolation Voltage	V_{ISO}	2,500	$V_{(RMS)}$
締め付けトルク Mounting Torque	Module Base to Heatsink	2	N·m (kgf·cm)
	Busbar to Main Terminal	2 (20.4)	

□ 電気的特性 : *ELECTRICAL CHARACTERISTICS* ($T_c = 25^\circ\text{C}$)

Characteristic	Symbol	Test Condition	Min.	Typ.	Max.	Unit
コレクタ遮断電流 Collector-Emitter Cut-Off Current	I_{CES}	$V_{CE} = 600V, V_{GE} = 0V$	—	—	1.0	mA
ゲート漏れ電流 Gate-Emitter Leakage Current	I_{GES}	$V_{GE} = \pm 20V, V_{CE} = 0V$	—	—	1.0	μA
コレクタ・エミッタ間飽和電圧 Collector-Emitter Saturation Voltage	$V_{CE(sat)}$	$I_C = 75A, V_{GE} = 15V$	—	2.1	2.6	V
ゲートしきい値電圧 Gate-Emitter Threshold Voltage	$V_{GE(th)}$	$V_{CE} = 5V, I_C = 75mA$	4.0	—	8.0	V
入力容量 Input Capacitance	C_{ies}	$V_{CE} = 10V, V_{GE} = 0V, f = 1MHz$	—	3,200	—	pF
スイッチング時間 Switching Time	上昇時間 Rise Time	$V_{CC} = 300V$ $R_L = 4.0\Omega$ $R_G = 12.0\Omega$ $V_{GE} = \pm 15V$	—	0.15	0.30	μs
	ターンオン時間 Turn-on Time		—	0.25	0.40	
	下降時間 Fall Time		—	0.10	0.35	
	ターンオフ時間 Turn-off Time		—	0.35	0.70	

□ フリーホイールダイオードの特性 : *FREE WHEELING DIODE RATINGS & CHARACTERISTICS* ($T_c = 25^\circ\text{C}$)

Item	Symbol	Rated Value	Unit
順電流 Forward Current	DC	75	A
	1ms	150	

Characteristic	Symbol	Test Condition	Min.	Typ.	Max.	Unit
順電圧 Peak Forward Voltage	V_F	$I_F = 75A, V_{GE} = 0V$	—	1.9	2.4	V
逆回復時間 Reverse Recovery Time	t_{rr}	$I_F = 75A, V_{GE} = -10V$ $di/dt = 150A/\mu\text{s}$	—	0.15	0.25	μs

□ 熱的特性 : *THERMAL CHARACTERISTICS*

Characteristic	Symbol	Test Condition	Min.	Typ.	Max.	Unit
熱抵抗 Thermal Impedance	IGBT	Junction to Case (T_c 測定点チップ直下)	—	—	0.38	$^\circ\text{C}/\text{W}$
	Diode		—	—	0.80	

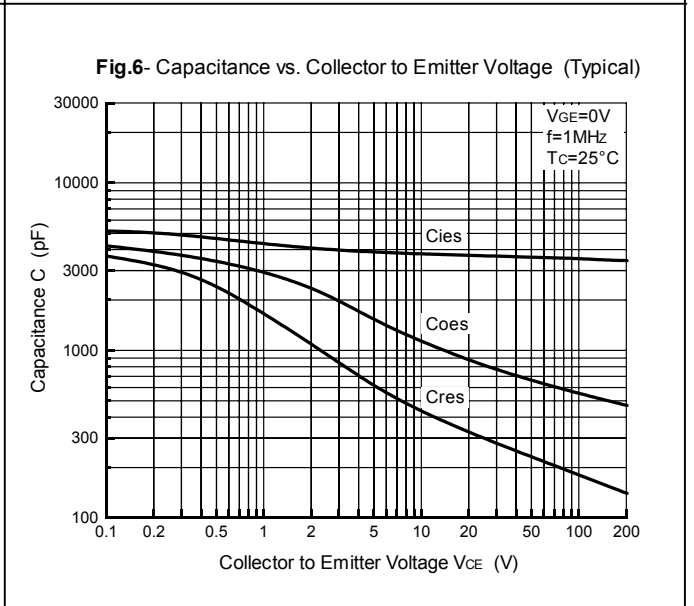
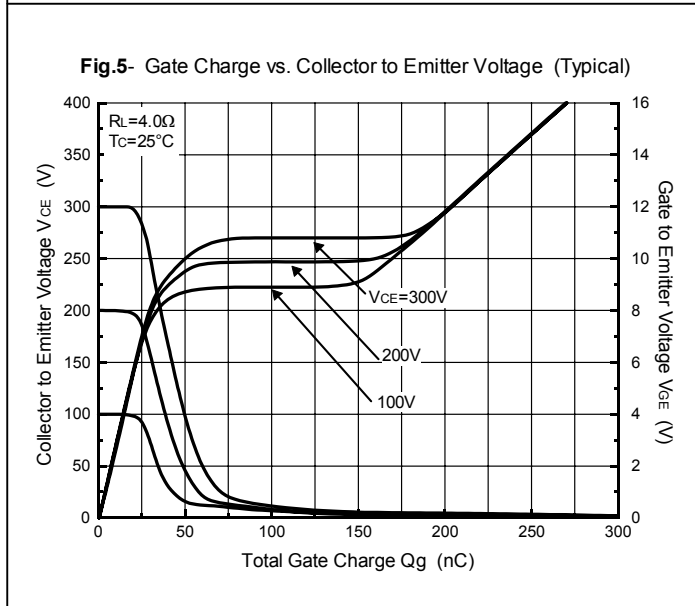
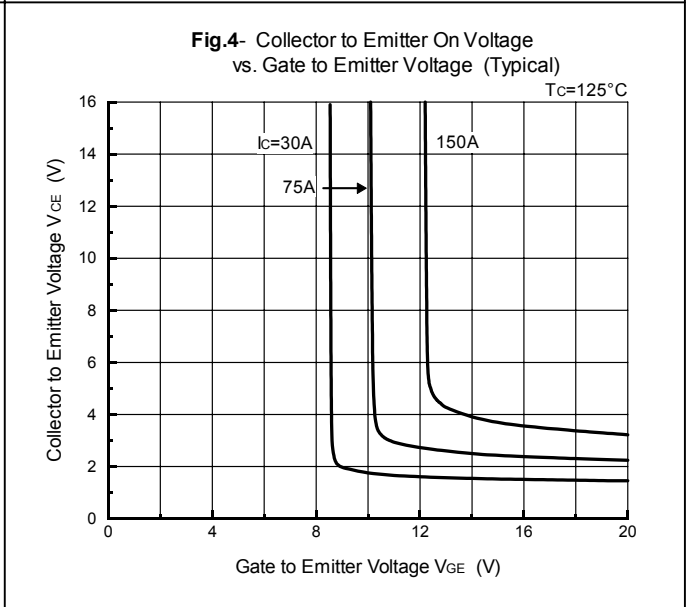
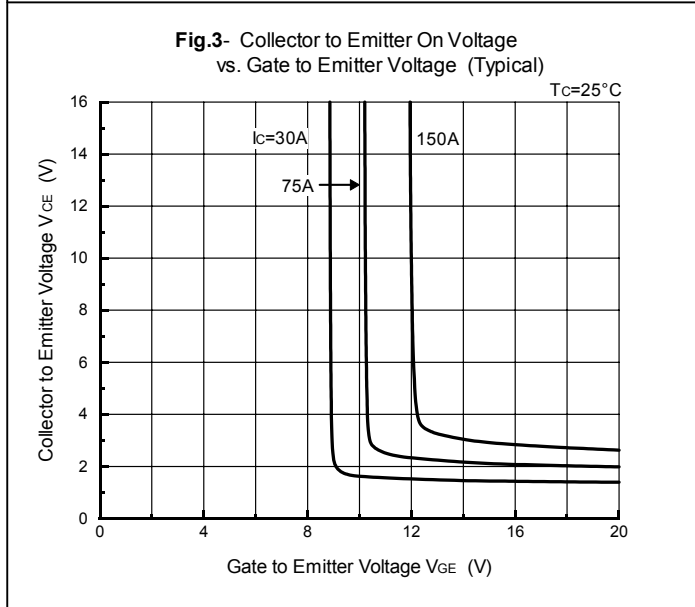
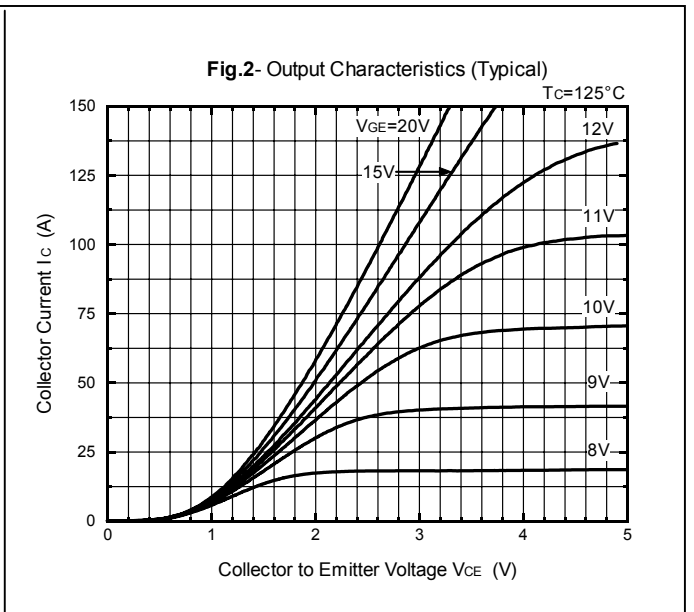
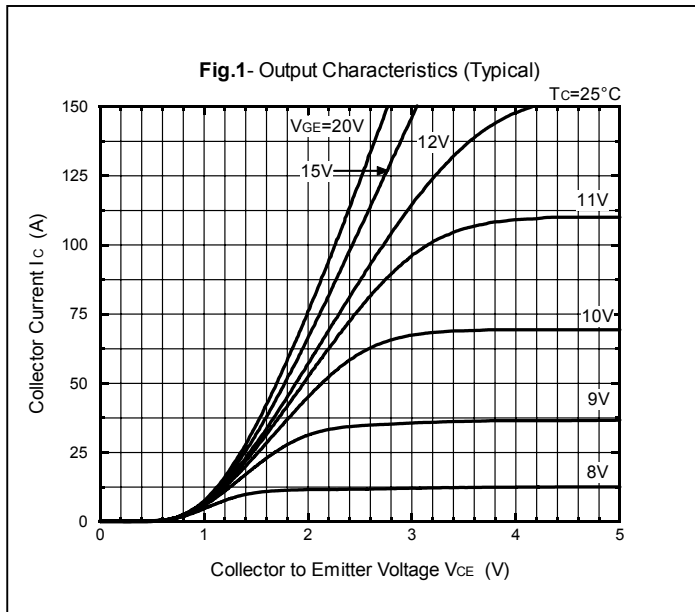

Fig.7- Collector Current vs. Switching Time (Typical)

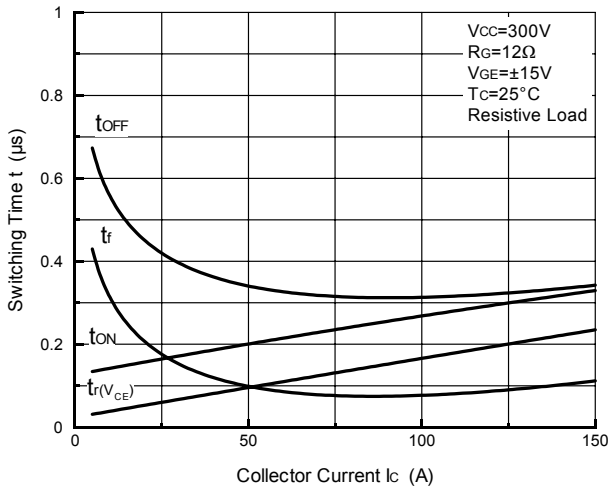

Fig.8- Series Gate Impedance vs. Switching Time (Typical)

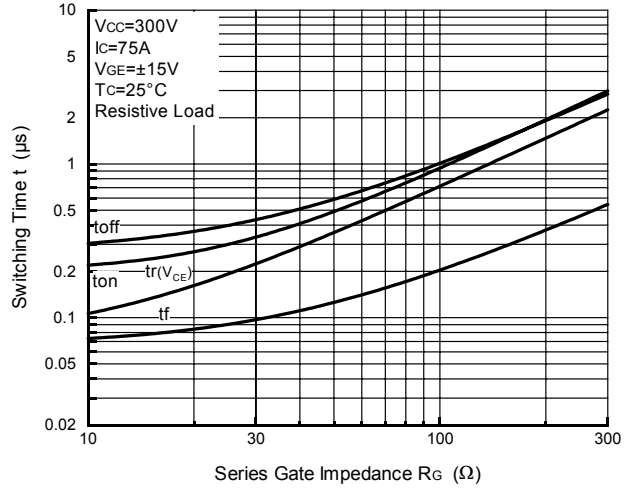

Fig.9- Collector Current vs. Switching Time

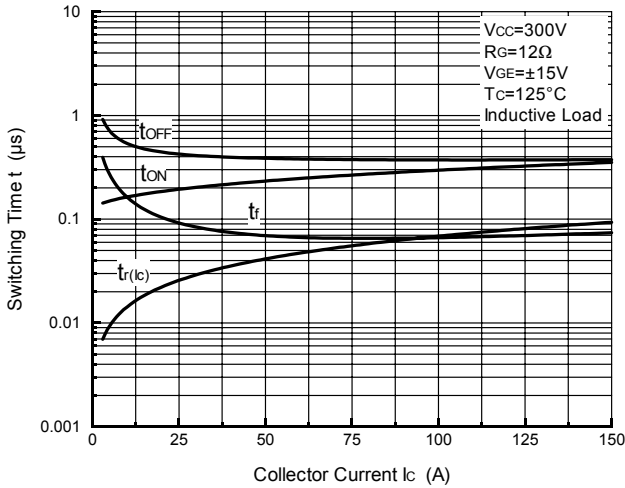

Fig.10- Series Gate Impedance vs. Switching Time

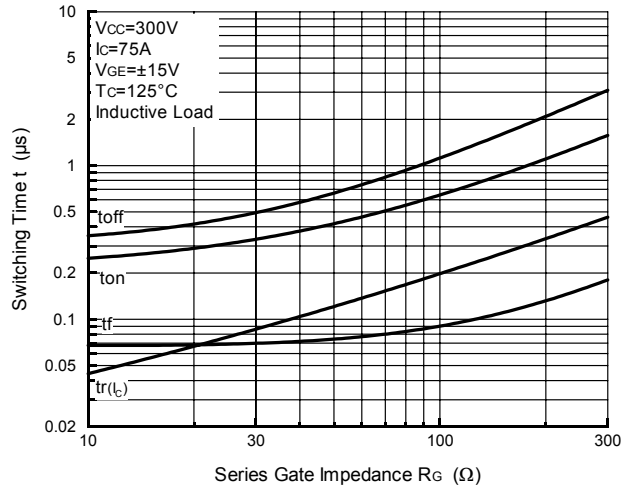

Fig.11- Collector Current vs. Switching Loss

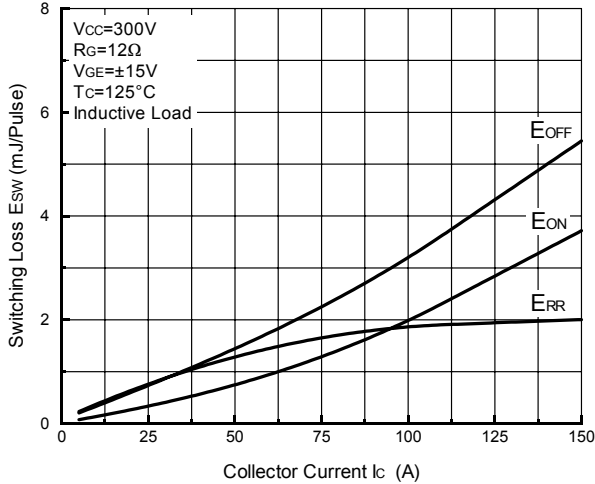

Fig.12- Series Gate Impedance vs. Switching Loss

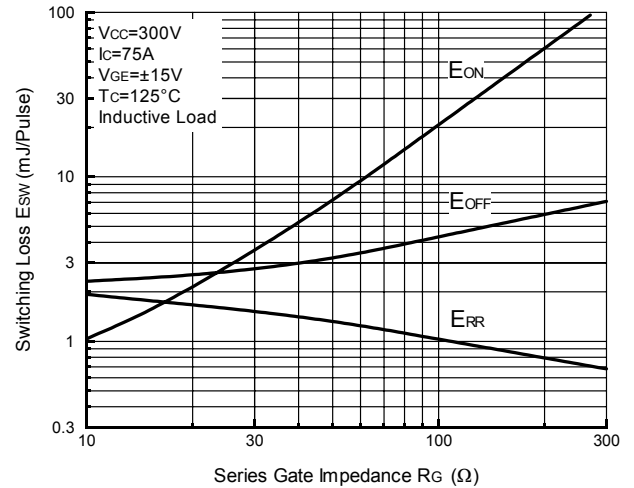

Fig.13- Forward Characteristics of Free Wheeling Diode (Typical)

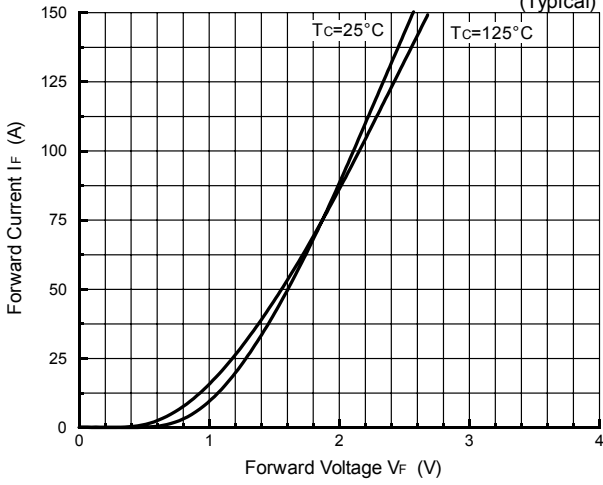

Fig.14- Reverse Recovery Characteristics (Typical)

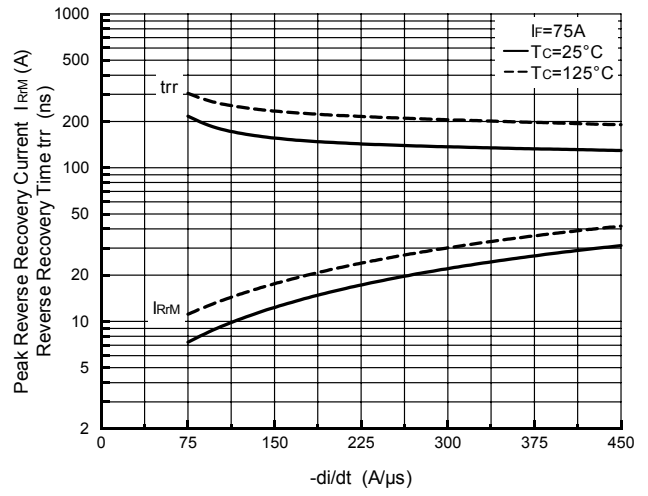

Fig.15- Reverse Bias Safe Operating Area

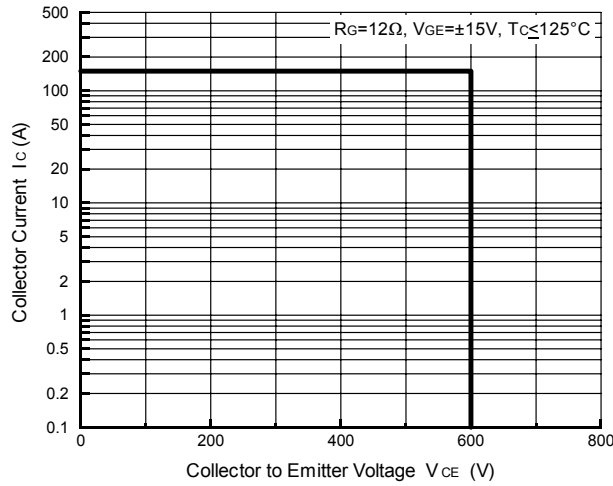

Fig.16- Transient Thermal Impedance

