

# THYRISTOR

## 100A Avg 1600 Volts

PDT10016  
PDH10016  
PCH10016

### ■回路図 CIRCUIT

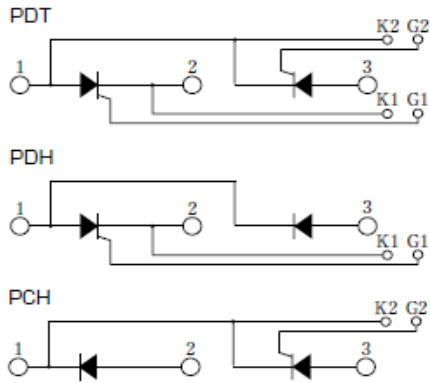

### ■外形寸法図 OUTLINE DRAWING

Dimension: [mm]

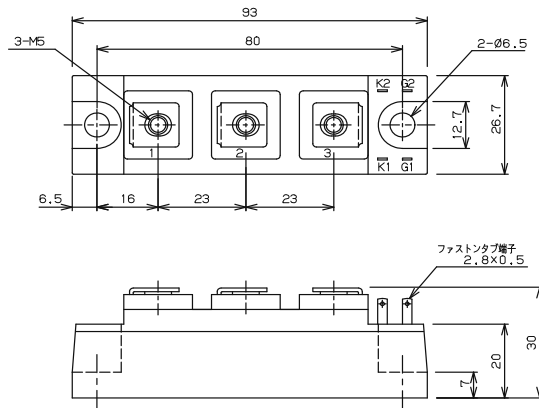

### ■最大定格 Maximum Ratings

項目 Parameter	記号 Symbol	耐圧クラス Grade		単位 Unit
		PDT10016/PDH10016/PCH10016		
くり返しピークオフ電圧 Repetitive Peak Off-State Voltage	$V_{DRM}$	1600		V
非くり返しピークオフ電圧 Non Repetitive Peak Off-State Voltage	$V_{DSM}$	1700		V
くり返しピーク逆電圧 Repetitive Peak Reverse Voltage	$V_{RRM}$	1600		V
非くり返しピーク逆電圧 Non Repetitive Peak Reverse Voltage	$V_{RSM}$	1700		V

項目 Parameter	記号 Symbol	条件 Conditions	定格値 Max. Rated Value	単位 Unit		
平均オン電流 Average On-State Current	$I_{O(AV)}$	商用周波数 180° 通電 $T_c=77^\circ C$ Half Sine Wave	100	A		
実効オン電流 RMS On-State Current	$I_{TRMS}$		156	A		
サージオン電流 Surge On-State Current	$I_{ISM}$	50Hz 正弦半波, 1サージ, 非くり返し Half Sine Wave, 1Pulse, Non-Repetitive	2000	A		
電流二乗時間積 I Squared t	$I^2t$	2~10ms	20000	$A^2 s$		
臨界オン電流上昇率 Critical Rate of Rise of Turned-On Current	di/dt	$V_D=2/3 V_{DRM}$ , $I_{TM}=2 \cdot I_O$ , $T_J=125^\circ C$ $I_G=200mA$ , $di/dt=0.2A/\mu s$	100	$A/\mu s$		
ピークゲート電力損失 Peak Gate Power	$P_{GM}$		5	W		
平均ゲート電力損失 Average Gate Power	$P_{G(AV)}$		1	W		
ピークゲート電流 Peak Gate Current	$I_{GM}$		2	A		
ピークゲート電圧 Peak Gate Voltage	$V_{GM}$		10	V		
ピークゲート逆電圧 Peak Gate Reverse Voltage	$V_{RGM}$		5	V		
動作接合温度範囲 Operating Junction Temperature Range	$T_{Jw}$		-40 ~ +125	$^\circ C$		
保存温度範囲 Storage Temperature Range	$T_{stg}$		-40 ~ +125	$^\circ C$		
絶縁耐圧 Isolation Voltage	Viso	端子ーベース間, AC 1分間 Terminal to Base, AC 1min.	2500	V		
締付トルク Mounting Torque	ベース部 Mounting	F	サマルコパッド 塗布 Greased	M6	2.4 ~ 3.5	$N \cdot m$
	主端子部 Terminal			M5	2.4 ~ 2.8	$N \cdot m$

■電気的特性 Electrical Characteristics

項目 Parameter	記号 Symbol	条件 Conditions	特性値 (最大) Maximum Value			単位 Unit
			最小 Min.	標準 Typ.	最大 Max.	
ピークオフ電流 Peak Off-State Current	IDM	T <sub>j</sub> =125°C, V <sub>DM</sub> =V <sub>DRM</sub>			20	mA
ピーク逆電流 Peak Reverse Current	IRM	T <sub>j</sub> =125°C, V <sub>RM</sub> =V <sub>RRM</sub>			20	mA
ピークオン電圧 Peak On-State Voltage	V <sub>TM</sub>	T <sub>j</sub> =25°C, I <sub>TM</sub> =300A			1.38	V
トリガゲート電流 Gate Current to Trigger	I <sub>GT</sub>	V <sub>D</sub> =6V, I <sub>T</sub> =1A	T <sub>j</sub> = -40°C		200	mA
			T <sub>j</sub> = 25°C		100	mA
			T <sub>j</sub> = 125°C		50	mA
			T <sub>j</sub> = -40°C		4	V
トリガゲート電圧 Gate Voltage to Trigger	V <sub>GT</sub>	V <sub>D</sub> =6V, I <sub>T</sub> =1A	T <sub>j</sub> = -40°C		4	V
			T <sub>j</sub> = 25°C		2.5	V
			T <sub>j</sub> = 125°C		2	V
非トリガゲート電圧 Gate Non-Trigger Voltage	V <sub>GD</sub>	T <sub>j</sub> =125°C, V <sub>D</sub> =2/3V <sub>DRM</sub>	0.25			V
臨界オフ電圧上昇率 Critical Rate of Rise of Off-State Voltage	dv/dt	T <sub>j</sub> =125°C, V <sub>D</sub> =2/3V <sub>DRM</sub>	500			V/μs
ターンオフ時間 Turn-Off Time	t <sub>q</sub>	T <sub>j</sub> =125°C, I <sub>TM</sub> =I <sub>O</sub> , V <sub>D</sub> =2/3V <sub>DRM</sub> dv/dt=20V/μs, V <sub>R</sub> =100V, -di/dt=20A/μs		100		μs
ターンオン時間 Turn-On Time	t <sub>gt</sub>			6		μs
遅れ時間 Delay Time	t <sub>d</sub>	T <sub>j</sub> =25°C, V <sub>D</sub> =2/3V <sub>DRM</sub> I <sub>G</sub> =200mA, di <sub>G</sub> /dt=0.2A/μs		2		μs
立上がり時間 Rise Time	t <sub>r</sub>			4		μs
ラッチング電流 Latching Current	I <sub>L</sub>	T <sub>j</sub> =25°C		100		mA
保持電流 Holding Current	I <sub>H</sub>	T <sub>j</sub> =25°C		50		mA
熱抵抗 Thermal Resistance	R <sub>th(j-c)</sub>	接合部-ケース間 Junction to Case			0.35	°C/W
接触熱抵抗 Thermal Resistance	R <sub>th(c-f)</sub>	ケース-フィン間, サーマルコンパウンド塗布 Case to Fin, Greased			0.2	°C/W

質量…約155g  
Approximate Weight

1アーム当りの値 Value Per 1 Arm.

■定格・特性曲線

オン電圧特性  
ON-STATE CURRENT VS. VOLTAGE

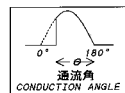
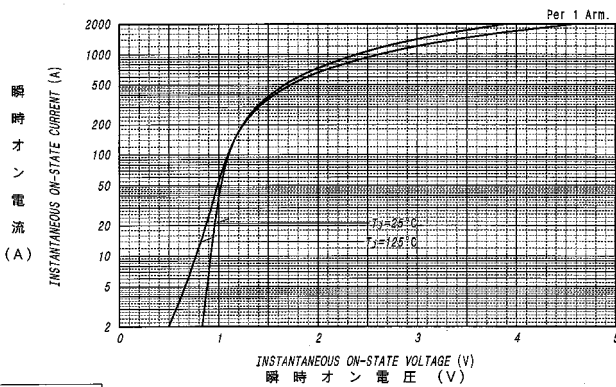

平均オン電力損失特性  
AVERAGE ON-STATE POWER DISSIPATION  
for SINUSOIDAL CURRENT WAVEFORM

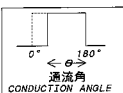
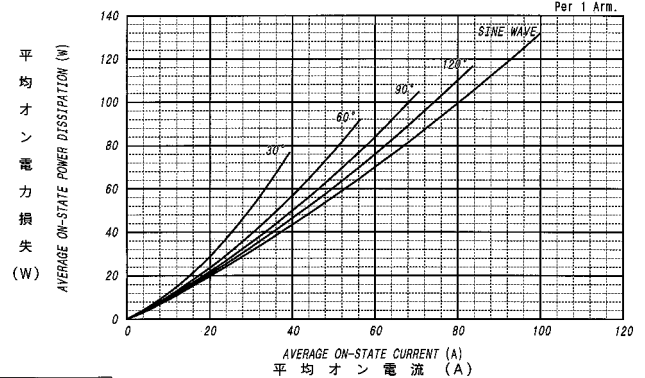

平均オン電力損失特性  
AVERAGE ON-STATE POWER DISSIPATION  
for RECTANGULAR CURRENT WAVEFORM

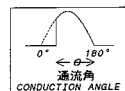
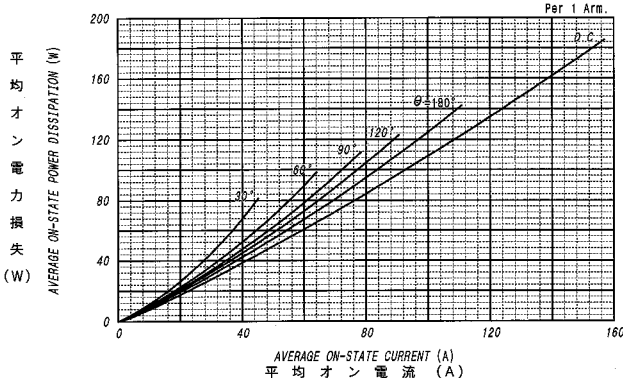

平均オン電流-ケース温度定格  
AVERAGE ON-STATE CURRENT VS. CASE TEMPERATURE

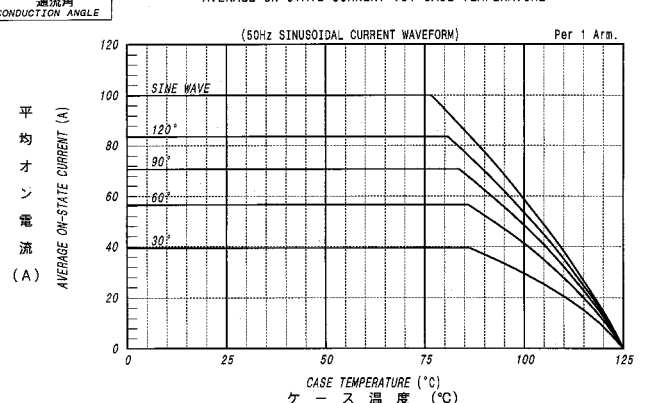

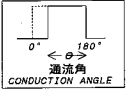

平均オン電流 - ケース温度定格  
AVERAGE ON-STATE CURRENT VS. CASE TEMPERATURE

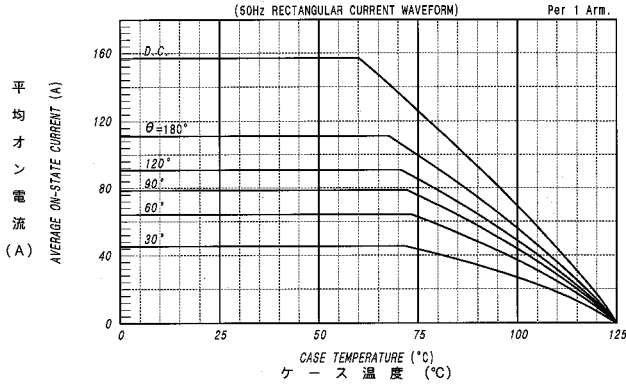

ゲート特性  
GATE CHARACTERISTICS

サージオン電流定格  
SURGE CURRENT RATINGS

f=50Hz, Half Sine Wave, Non-Repetitive, Tj=125°C

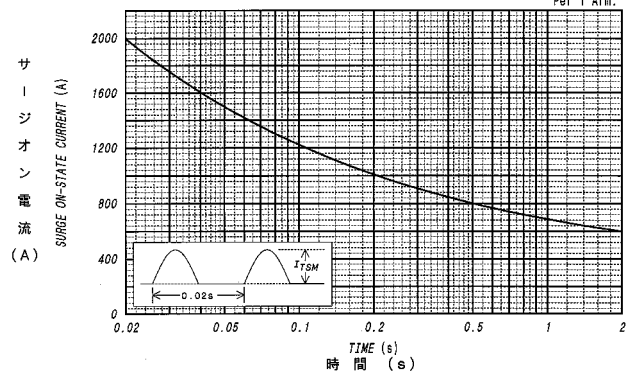

ゲート定格  
GATE RATINGS

トリガゲート電圧 (V)

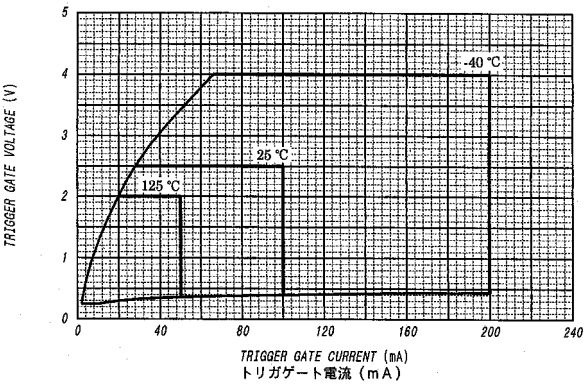

過渡熱抵抗特性  
MAXIMUM TRANSIENT THERMAL IMPEDANCE  
Junction to Case

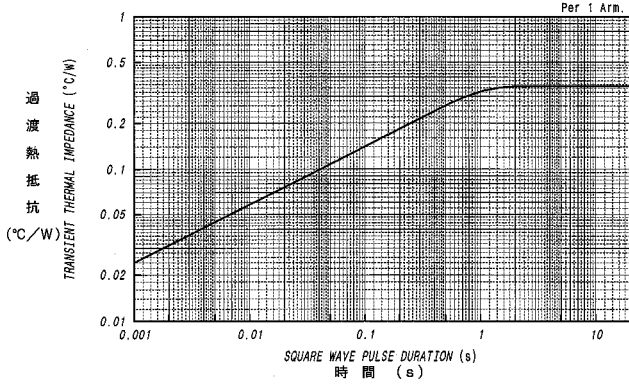

ゲート電圧 (V)

