

THYRISTOR

400 A Avg 800 Volts

PDT400N8 PDH400N8
PCH400N8 PAT400N8
PAH400N8

■回路図 CIRCUIT

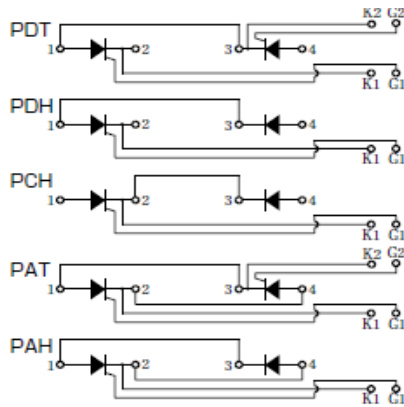

■外形寸法図 OUTLINE DRAWING

Dimension: [mm]

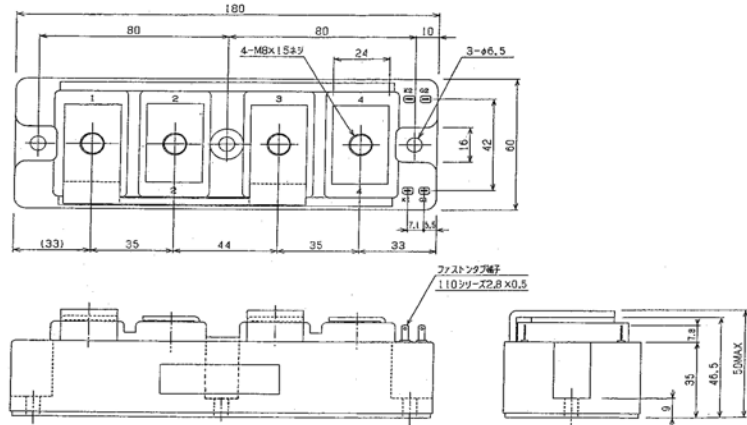

■最大定格 Maximum Ratings

項目 Parameter	記号 Symbol	耐圧クラス Grade		単位 Unit
		PDT/PDH/PCH/PAT/PAH400N8		
くり返しピークオフ電圧 Repetitive Peak Off-State Voltage	V_{DRM}	800		V
非くり返しピークオフ電圧 Non Repetitive Peak Off-State Voltage	V_{DSM}	900		V
くり返しピーク逆電圧 Repetitive Peak Reverse Voltage	V_{RRM}	800		V
非くり返しピーク逆電圧 Non Repetitive Peak Reverse Voltage	V_{RSM}	900		V

項目 Parameter	記号 Symbol	条件 Conditions	定格値	単位 Unit		
			Max.Rated Value			
平均オン電流 Average On-State Current	$I_{O(AV)}$	商用周波数 180° 通電 $T_c=78^\circ\text{C}$ Half Sine Wave	400	A		
実効オン電流 RMS On-State Current	I_{TRMS}		630	A		
サージオン電流 Surge On-State Current	I_{ISM}	50Hz 正弦半波, 1サイクル, 非くり返し Half Sine Wave, 1Pulse, Non-Repetitive	7500	A		
電流二乗時間積 I Squared t	I^2t	2~10ms	281000	A^2s		
臨界オン電流上昇率 Critical Rate of Rise of Turned-On Current	di/dt	$V_D=2/3 V_{DRM}$, $I_{TM}=2 \cdot I_O$, $T_j=125^\circ\text{C}$ $I_G=300\text{mA}$, $di/dt=0.2\text{A}/\mu\text{s}$	100	$\text{A}/\mu\text{s}$		
ピークゲート電力損失 Peak Gate Power	P_{GM}		5	W		
平均ゲート電力損失 Average Gate Power	$P_{G(AV)}$		1	W		
ピークゲート電流 Peak Gate Current	I_{GM}		2	A		
ピークゲート電圧 Peak Gate Voltage	V_{GM}		10	V		
ピークゲート逆電圧 Peak Gate Reverse Voltage	V_{RGM}		5	V		
動作接合温度範囲 Operating Junction Temperature Range	T_{jw}		-40 ~ +125	$^\circ\text{C}$		
保存温度範囲 Storage Temperature Range	T_{stg}		-40 ~ +125	$^\circ\text{C}$		
絶縁耐圧 Isolation Voltage	V_{iso}	端子-ベース間, AC 1分間 Terminal to Base, AC 1min.	2500	V		
締付トルク Mounting Torque	ベース部 Mounting	F	サマロノパウンド塗布 Greased	M6	2.5 ~ 3.5	$\text{N} \cdot \text{m}$
	主端子部 Terminal		M8	9.0 ~ 10.0	$\text{N} \cdot \text{m}$	

■ 電気的特性 Electrical Characteristics

項目 Parameter	記号 Symbol	条件 Conditions	特性値 (最大) Maximum Value			単位 Unit
			最小 Min	標準 Typ	最大 Max	
ピークオフ電流 Peak Off-State Current	I_{DM}	$T_j = 125^\circ\text{C}$, $V_{DM} = V_{DRM}$			50	mA
ピーク逆電流 Peak Reverse Current	I_{RM}	$T_j = 125^\circ\text{C}$, $V_{RM} = V_{RRM}$			50	mA
ピークオン電圧 Peak Off-State Voltage	V_{TM}	$T_j = 25^\circ\text{C}$, $I_{TM} = 1300\text{A}$			1.43	V
トリガゲート電流 Gate Current to Trigger	I_{GT}	$V_D = 6\text{V}$, $I_T = 1\text{A}$	$T_j = -40^\circ\text{C}$		300	mA
			$T_j = 25^\circ\text{C}$		150	
			$T_j = 125^\circ\text{C}$		80	
トリガゲート電圧 Gate Voltage to Trigger	V_{GT}	$V_D = 6\text{V}$, $I_T = 1\text{A}$	$T_j = -40^\circ\text{C}$		5	V
			$T_j = 25^\circ\text{C}$		3	
			$T_j = 125^\circ\text{C}$		2	
非トリガゲート電圧 Gate Non-Trigger Voltage	V_{GD}	$T_j = 125^\circ\text{C}$, $V_D = 2/3 V_{DRM}$	0.25			V
臨界オフ電圧上昇率 Critical Rate of Rise of Off-State Voltage	dv/dt	$T_j = 125^\circ\text{C}$, $V_D = 2/3 V_{DRM}$	500			V/ μs
ターンオフ時間 Turn-Off Time	t_q	$T_j = 125^\circ\text{C}$, $I_{TM} = I_o$, $V_D = 2/3 V_{DRM}$ $dv/dt = 20\text{V}/\mu\text{s}$, $V_R = 100\text{V}$, $-di/dt = 20\text{A}/\mu\text{s}$				μs
ターンオン時間 Turn-On Time	t_{gt}	$T_j = 25^\circ\text{C}$, $V_D = 2/3 V_{DRM}$ $I_G = 300\text{mA}$, $di_G/dt = 0.2\text{A}/\mu\text{s}$		6		μs
遅れ時間 Delay Time	t_d			2		μs
立ち上がり時間 Rise Time	t_r			4		μs
ラッチング電流 Latching Current	I_L	$T_j = 25^\circ\text{C}$		150		mA
保持電流 Holding Current	I_H	$T_j = 25^\circ\text{C}$		60		mA
熱抵抗 Thermal Resistance	$R_{th(j-c)}$	接合部-ケース間 Junction to Case			0.08	$^\circ\text{C}/\text{W}$
接触熱抵抗 Thermal Resistance	$R_{th(c-f)}$	ケースフィン間, サーマロンパウンド塗布 Case to Fin, Greased			0.05	$^\circ\text{C}/\text{W}$

質量 --- 約960g
Approximate Weight

1アーム当りの値 Value Per 1 Arm.

■ 定格・特性曲線

オン電圧特性
ON-STATE CURRENT VS. VOLTAGE

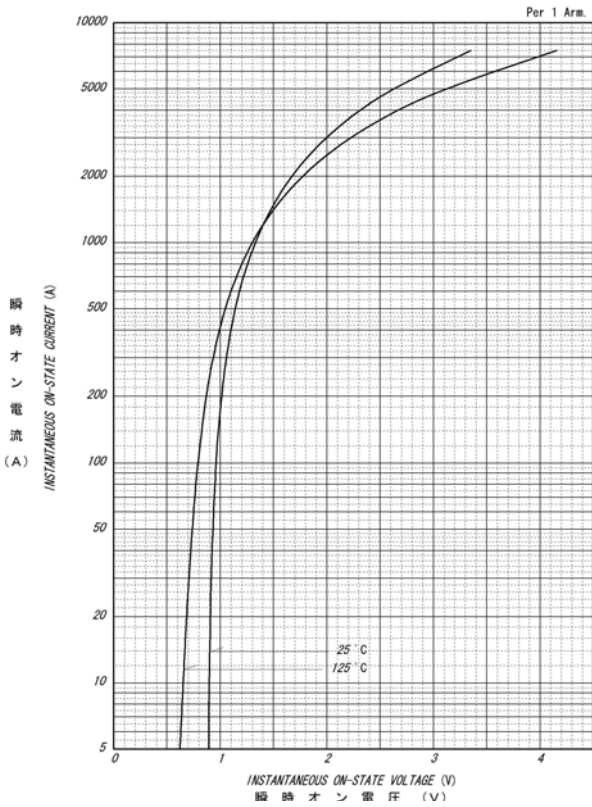

平均オン電力損失特性
AVERAGE ON-STATE POWER DISSIPATION

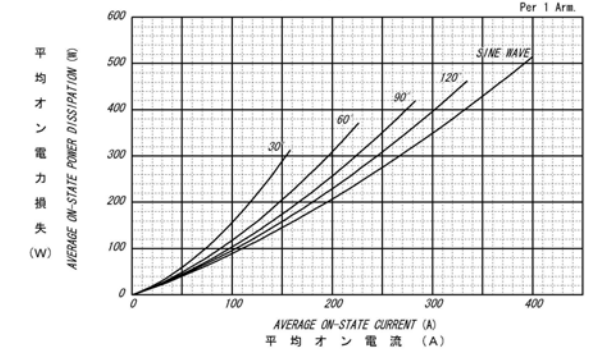

平均オン電力損失特性
AVERAGE ON-STATE POWER DISSIPATION

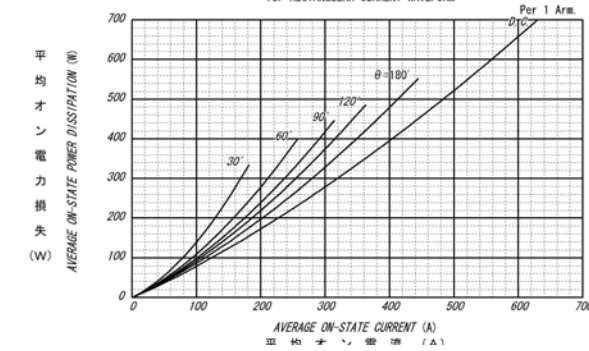

平均オン電流 - ケース温度定格
AVERAGE ON-STATE CURRENT VS. CASE TEMPERATURE

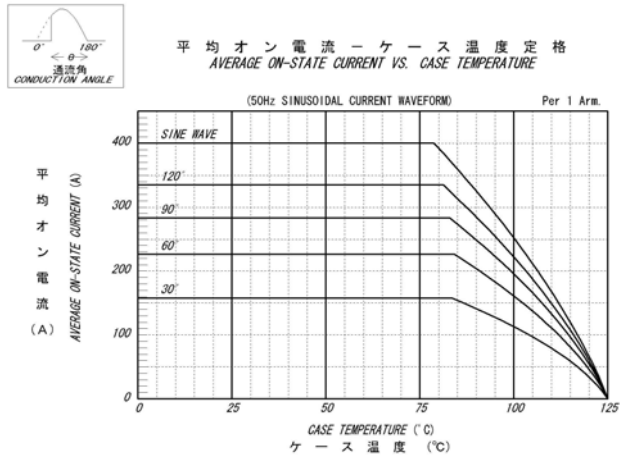

平均オン電流 - ケース温度定格
AVERAGE ON-STATE CURRENT VS. CASE TEMPERATURE

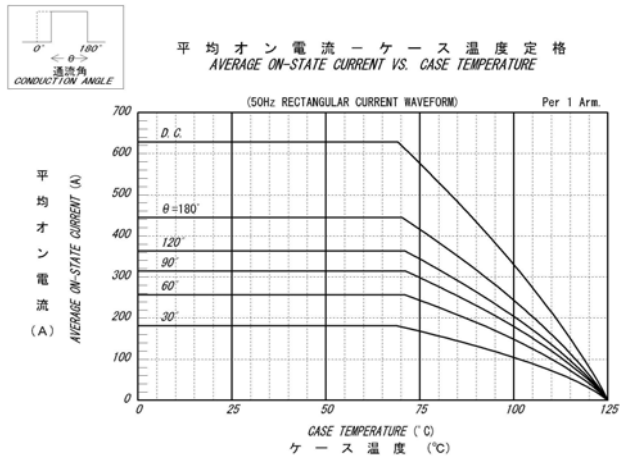

サージオン電流定格
SURGE CURRENT RATINGS

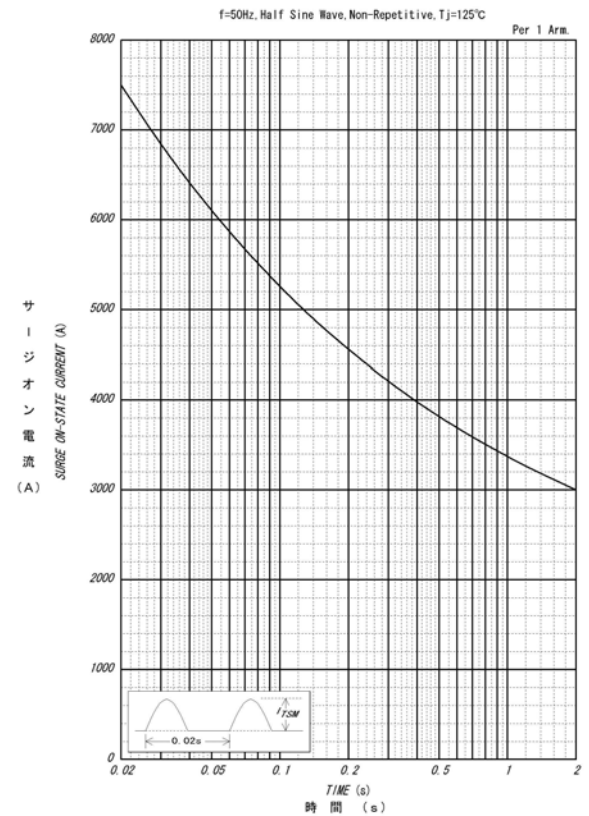

ゲート特性
GATE CHARACTERISTICS

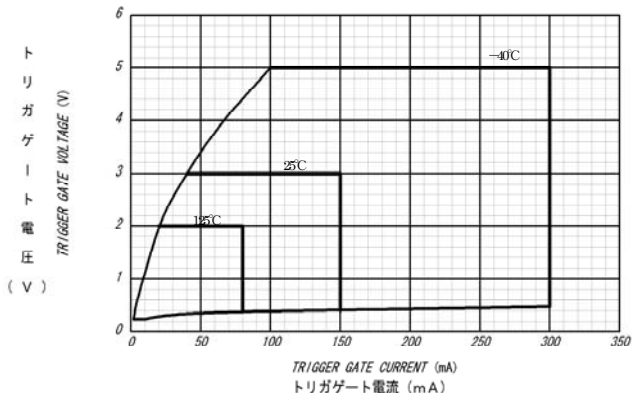

ゲート定格
GATE RATINGS

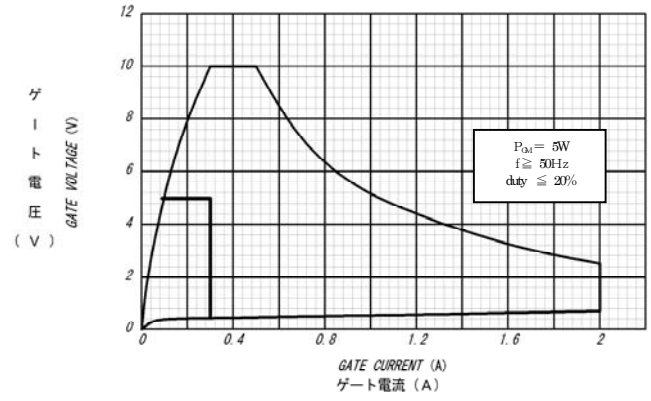

過渡熱抵抗特性
MAXIMUM TRANSIENT THERMAL IMPEDANCE
Junction to Case

