

IGBT Module-Dual

150 A, 1200V

PDMB150B12C

PDMB150B12C2

回路図 : CIRCUIT

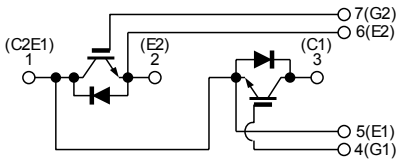

外形寸法図 : OUTLINE DRAWING

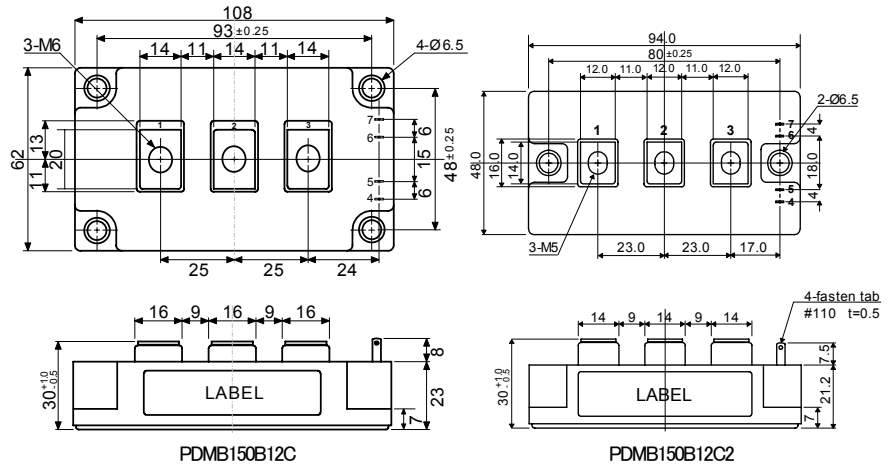

Dimension: [mm]

最大定格 : MAXIMUM RATINGS (T_c = 25°C)

Item	Symbol	Rated Value	Unit
コレクタ・エミッタ間電圧 Collector-Emitter Voltage	V _{CEs}	1,200	V
ゲート・エミッタ間電圧 Gate-Emitter Voltage	V _{GES}	±20	V
コレクタ電流 Collector Current	DC	I _C 150	A
	1ms	I _{CP} 300	
コレクタ損失 Collector Power Dissipation	P _C	730	W
接合温度 Junction Temperature Range	T _j	-40~+150	°C
保存温度 Storage Temperature Range	T _{stg}	-40~+125	°C
絶縁耐圧(Terminal to Base AC, 1 minute) Isolation Voltage	V _{ISO}	2,500	V _(RMS)
締め付けトルク Mounting Torque	Module Base to Heatsink Busbar to Main Terminal	3 (30.6)	
		PDMB150B12C 3 (30.6)	PDMB150B12C2 2 (20.4)
			N·m (kgf·cm)

電氣的特性 : ELECTRICAL CHARACTERISTICS (T_c = 25°C)

Characteristic	Symbol	Test Condition	Min.	Typ.	Max.	Unit
コレクタ遮断電流 Collector-Emitter Cut-Off Current	I _{CEs}	V _{CE} = 1200V, V _{GE} = 0V	-	-	3.0	mA
ゲート漏れ電流 Gate-Emitter Leakage Current	I _{GES}	V _{GE} = ±20V, V _{CE} = 0V	-	-	1.0	μA
コレクタ・エミッタ間飽和電圧 Collector-Emitter Saturation Voltage	V _{CE(sat)}	I _C = 150A, V _{GE} = 15V	-	1.9	2.4	V
ゲートしきい値電圧 Gate-Emitter Threshold Voltage	V _{GE(th)}	V _{CE} = 5V, I _C = 150mA	4.0	-	8.0	V
入力容量 Input Capacitance	C _{ies}	V _{CE} = 10V, V _{GE} = 0V, f = 1MHz	-	12,600	-	pF
スイッチング時間 Switching Time	上昇時間 Rise Time	V _{CC} = 600V R _L = 4Ω R _G = 3.6Ω V _{GE} = ±15V	-	0.25	0.45	μs
	ターンオン時間 Turn-on Time		-	0.40	0.70	
	下降時間 Fall Time		-	0.25	0.35	
	ターンオフ時間 Turn-off Time		-	0.80	1.10	

フリーホイールダイオードの特性 : FREE WHEELING DIODE RATINGS & CHARACTERISTICS (T_c = 25°C)

Item	Symbol	Rated Value	Unit
順電流 Forward Current	DC	I _F 150	A
	1ms	I _{FM} 300	

Characteristic	Symbol	Test Condition	Min.	Typ.	Max.	Unit
順電圧 Peak Forward Voltage	V _F	I _F = 150A, V _{GE} = 0V	-	1.9	2.4	V
逆回復時間 Reverse Recovery Time	t _{rr}	I _F = 150A, V _{GE} = -10V di/dt = 300A/μs	-	0.2	0.3	μs

熱的特性 : THERMAL CHARACTERISTICS

Characteristic	Symbol	Test Condition	Min.	Typ.	Max.	Unit
熱抵抗 Thermal Impedance	IGBT	Junction to Case	-	-	0.16	°C/W
	Diode		-	-	0.32	

PDMB 150B12

PDMB 150B12C

Fig.1- Output Characteristics (Typical)

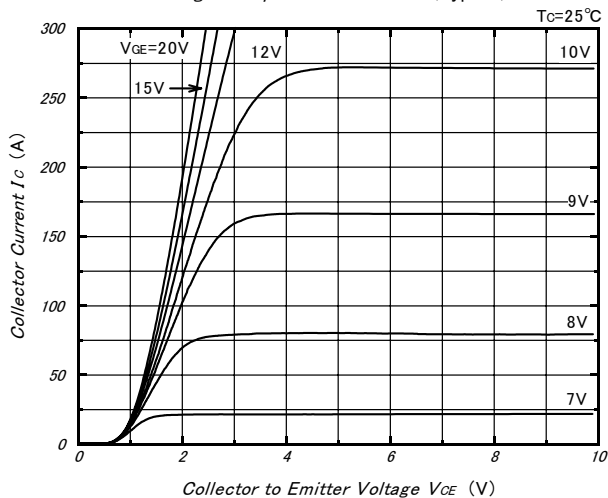

Fig.2- Collector to Emitter On Voltage vs. Gate to Emitter Voltage (Typical)

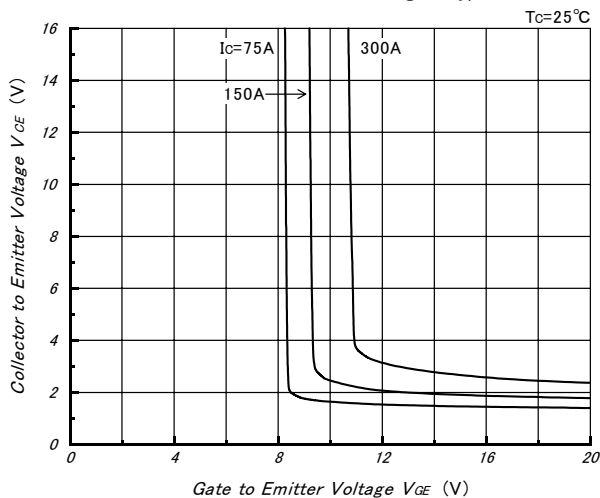

Fig.3- Collector to Emitter On Voltage vs. Gate to Emitter Voltage (Typical)

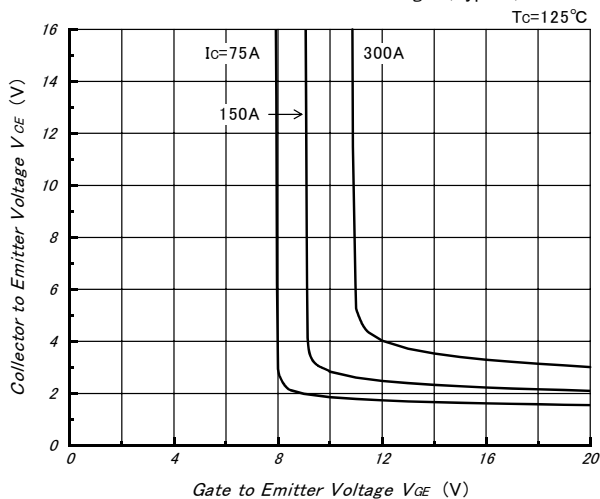

Fig.4- Gate Charge vs. Collector to Emitter Voltage (Typical)

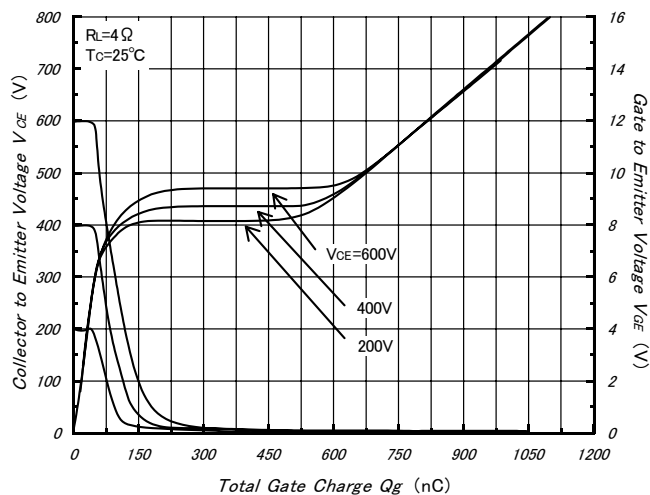

Fig.5- Capacitance vs. Collector to Emitter Voltage (Typical)

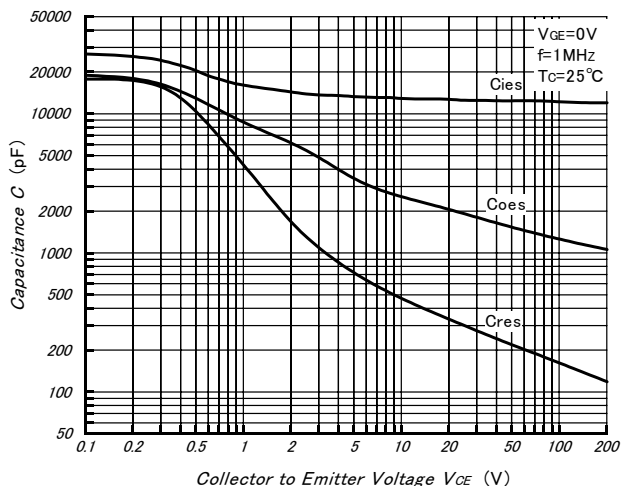
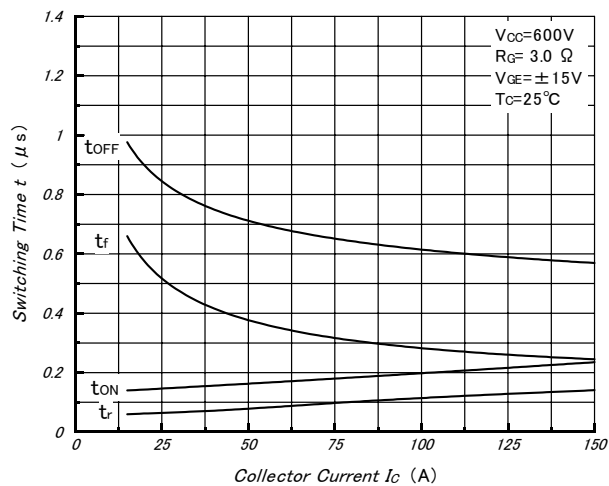

Fig.6- Collector Current vs. Switching Time (Typical)



PDMB150B12

PDMB150B12C

Fig.7- Series Gate Impedance vs. Switching Time (Typical)

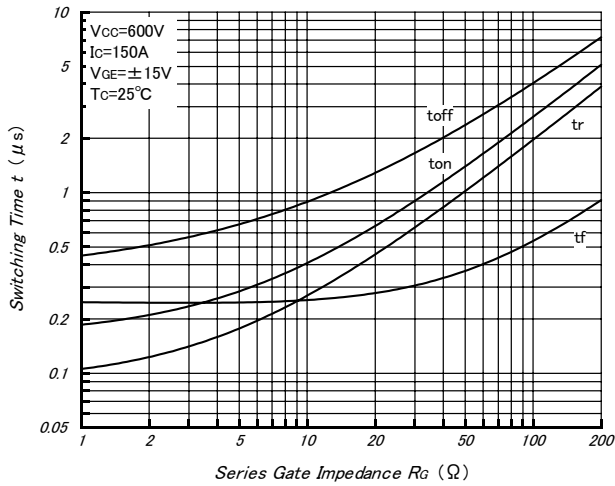

Fig.8- Forward Characteristics of Free Wheeling Diode (Typical)

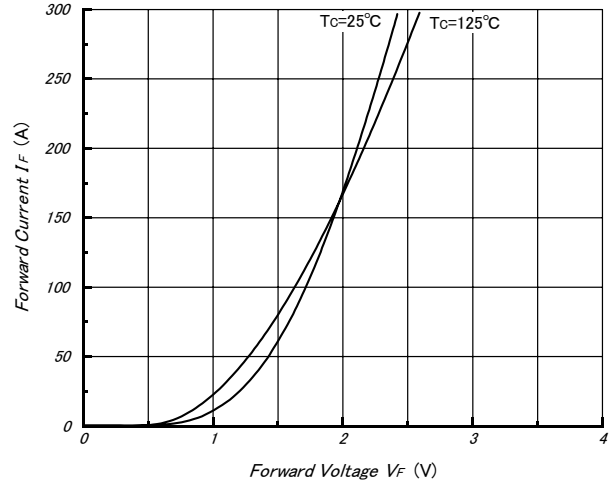

Fig.9- Reverse Recovery Characteristics (Typical)

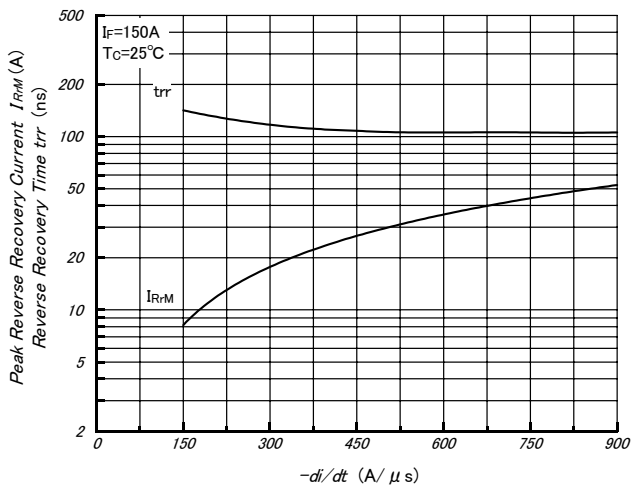

Fig.10- Reverse Bias Safe Operating Area

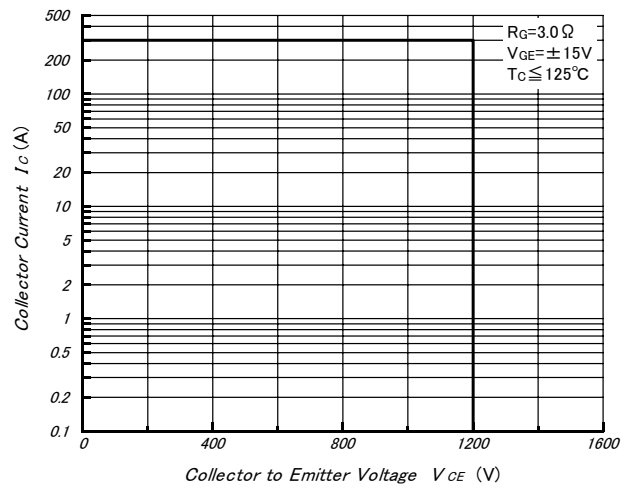

Fig.11- Transient Thermal Impedance

