

□ 回路図 : **CIRCUIT**

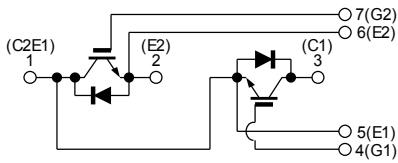

□ 外形寸法図 : **OUTLINE DRAWING**

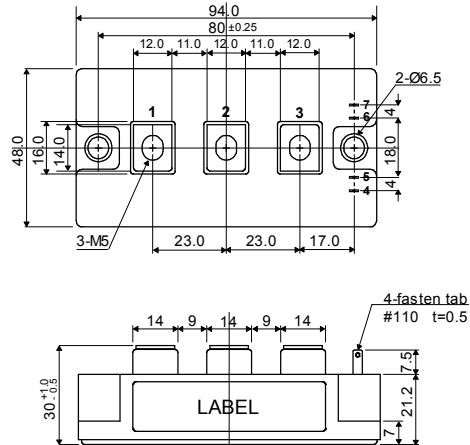

Dimension: [mm]

□ 最大定格 : **MAXIMUM RATINGS** (at  $T_c=25^\circ\text{C}$  unless otherwise specified)

Item	Symbol	Rated Value	Unit
コレクタ・エミッタ間電圧 Collector-Emitter Voltage	$V_{CES}$	600	V
ゲート・エミッタ間電圧 Gate-Emitter Voltage	$V_{GES}$	$\pm 20$	V
コレクタ電流 Collector Current	DC	150	A
	1ms	300	
コレクタ損失 Collector Power Dissipation	$P_C$	560	W
接合温度 Junction Temperature Range	$T_j$	$-40 \sim +150$	$^\circ\text{C}$
保存温度 Storage Temperature Range	$T_{stg}$	$-40 \sim +125$	$^\circ\text{C}$
絶縁耐圧 (Terminal to Base AC, 1minute) Isolation Voltage	$V_{iso}$	2,500	V (RMS)
締め付けトルク Mounting Torque	Module Base to Heatsink	3 (30.6)	N·m (kgf·cm)
	Busbar to Main Terminal	2 (20.4)	

□ 電気的特性 : **ELECTRICAL CHARACTERISTICS** (at  $T_j=25^\circ\text{C}$  unless otherwise specified)

Characteristic	Symbol	Test Condition	Min.	Typ.	Max.	Unit
コレクタ遮断電流 Collector-Emitter Cut-Off Current	$I_{CES}$	$V_{CE} = 600\text{V}, V_{GE} = 0\text{V}$	—	—	1.0	mA
ゲート漏れ電流 Gate-Emitter Leakage Current	$I_{GES}$	$V_{GE} = \pm 20\text{V}, V_{CE} = 0\text{V}$	—	—	1.0	$\mu\text{A}$
コレクタ・エミッタ間飽和電圧 Collector-Emitter Saturation Voltage	$V_{CE(sat)}$	$I_C = 150\text{A}, V_{GE} = 15\text{V}$	—	2.1	2.6	V
ゲートしきい値電圧 Gate-Emitter Threshold Voltage	$V_{GE(th)}$	$V_{CE} = 5\text{V}, I_C = 150\text{mA}$	4.0	—	8.0	V
入力容量 Input Capacitance	$C_{ies}$	$V_{CE} = 10\text{V}, V_{GE} = 0\text{V}, f = 1\text{MHz}$	—	7,500	—	pF
スイッチング時間 Switching Time	上昇時間 Rise Time	$V_{CC} = 300\text{V}$ $R_L = 2.0\Omega$ $R_G = 5.1\Omega$ $V_{GE} = \pm 15\text{V}$	—	0.15	0.30	$\mu\text{s}$
	ターンオン時間 Turn-on Time		—	0.25	0.40	
	下降時間 Fall Time		—	0.10	0.35	
	ターンオフ時間 Turn-off Time		—	0.35	0.70	

□ フリーホイールダイオードの特性 : **FREE WHEELING DIODE RATINGS & CHARACTERISTICS** (at  $T_c=25^\circ\text{C}$ ) & **CHARACTERISTICS** (at  $T_j=25^\circ\text{C}$ )

Item	Symbol	Rated Value	Unit
順電流 Forward Current	DC	150	A
	1ms	300	

Characteristic	Symbol	Test Condition	Min.	Typ.	Max.	Unit
順電圧 Peak Forward Voltage	$V_F$	$I_F = 150\text{A}, V_{GE} = 0\text{V}$	—	1.9	2.4	V
逆回復時間 Reverse Recovery Time	$t_{rr}$	$I_F = 150\text{A}, V_{GE} = -10\text{V}$ $di/dt = 300\text{A}/\mu\text{s}$	—	0.15	0.25	$\mu\text{s}$

□ 熱的特性 : **THERMAL CHARACTERISTICS**

Characteristic	Symbol	Test Condition	Min.	Typ.	Max.	Unit
熱抵抗 Thermal Impedance	IGBT	Junction to Case ( $T_c$ チップ直下での測定点)	—	—	0.22	$^\circ\text{C}/\text{W}$
	Diode		—	—	0.45	

**Fig.1- Output Characteristics (Typical)**

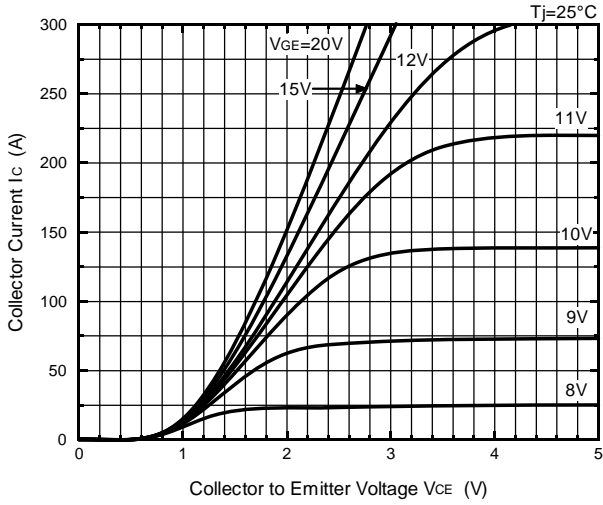

**Fig.2- Output Characteristics (Typical)**

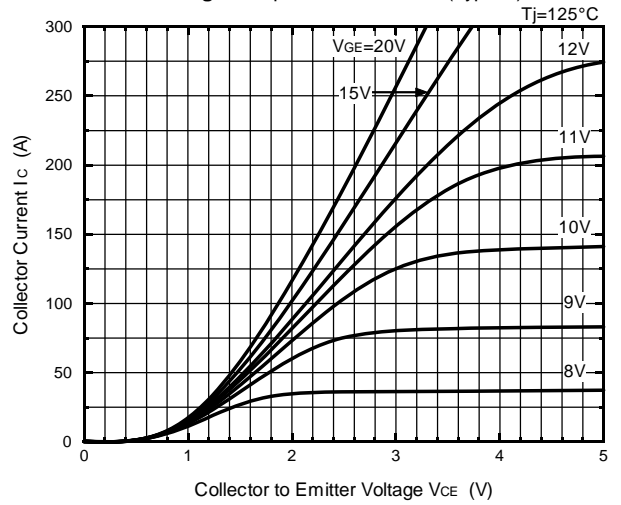

**Fig.3- Collector to Emitter On Voltage vs. Gate to Emitter Voltage (Typical)**

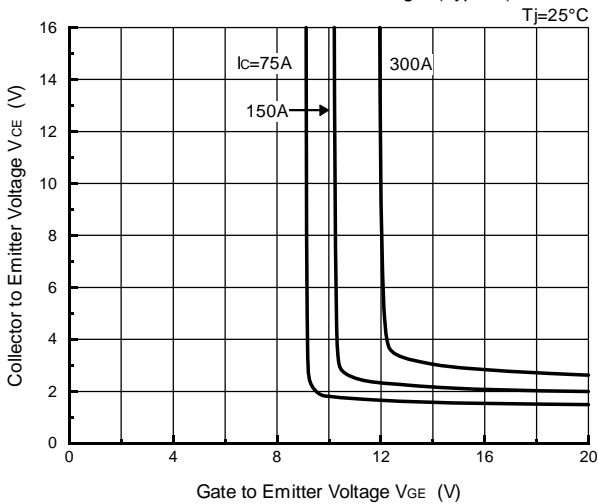

**Fig.4- Collector to Emitter On Voltage vs. Gate to Emitter Voltage (Typical)**

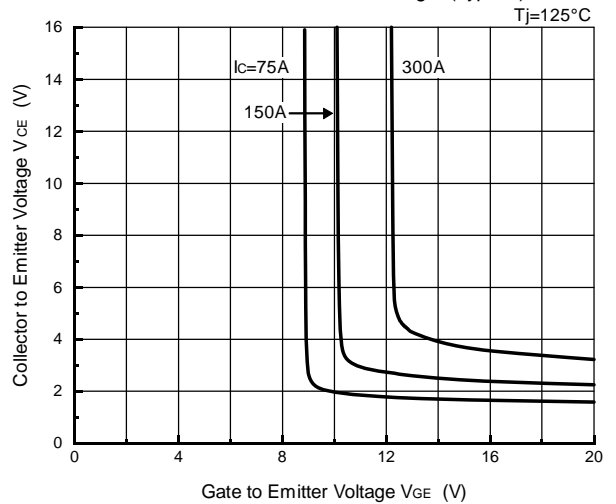

**Fig.5- Gate Charge vs. Collector to Emitter Voltage (Typical)**

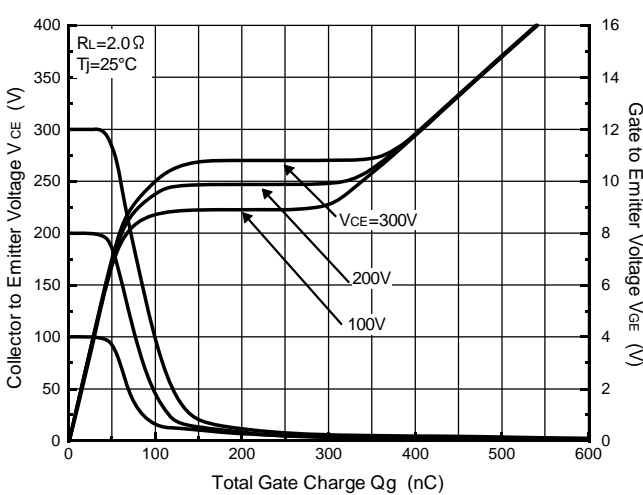

**Fig.6- Capacitance vs. Collector to Emitter Voltage (Typical)**

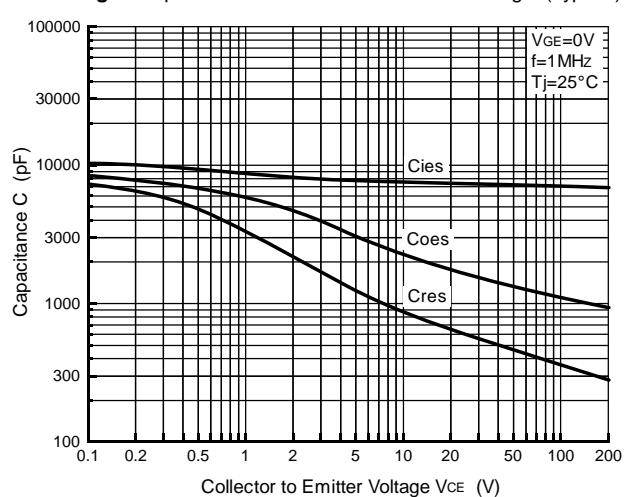

**Fig.7- Collector Current vs. Switching Time (Typical)**

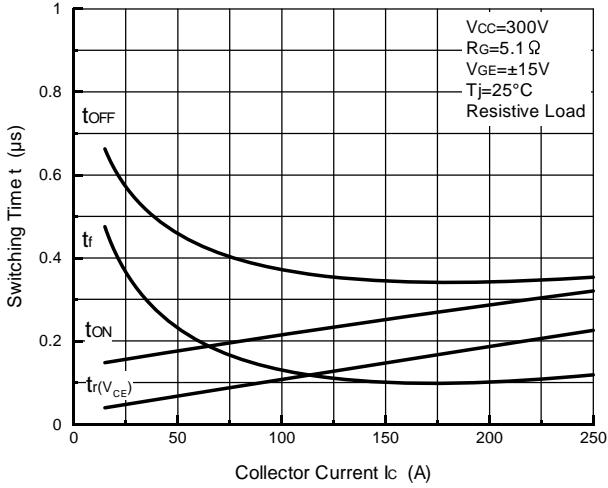

**Fig.8- Series Gate Impedance vs. Switching Time (Typical)**

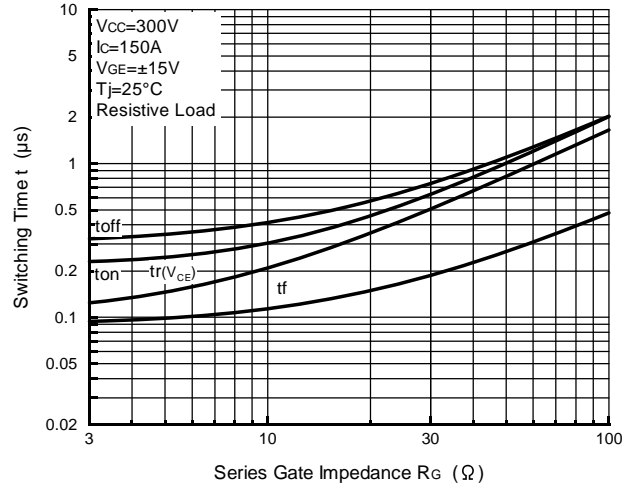

**Fig.9- Collector Current vs. Switching Time**

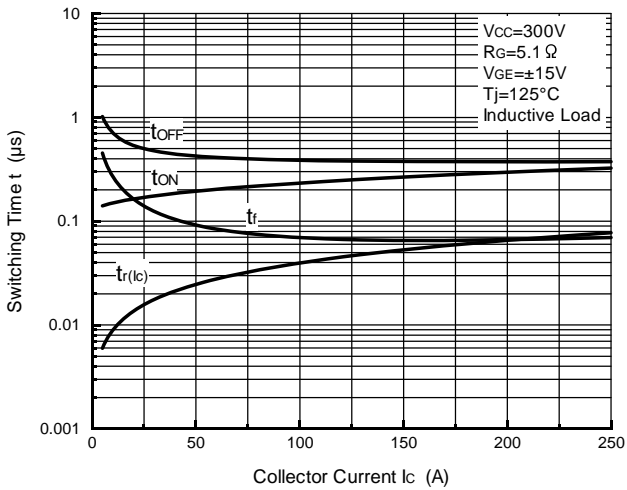

**Fig.10- Series Gate Impedance vs. Switching Time**

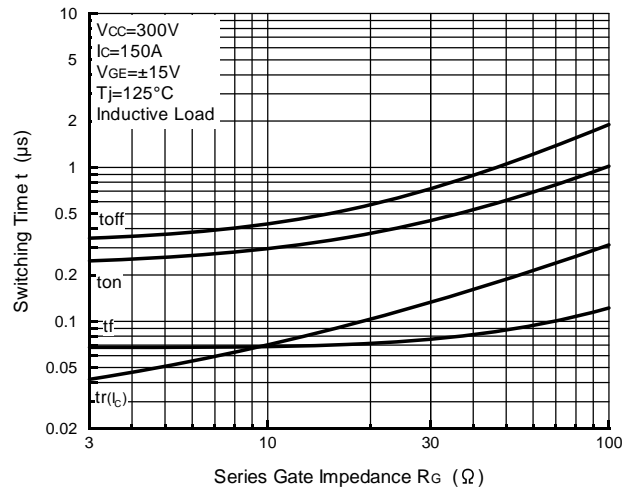

**Fig.11- Collector Current vs. Switching Loss**

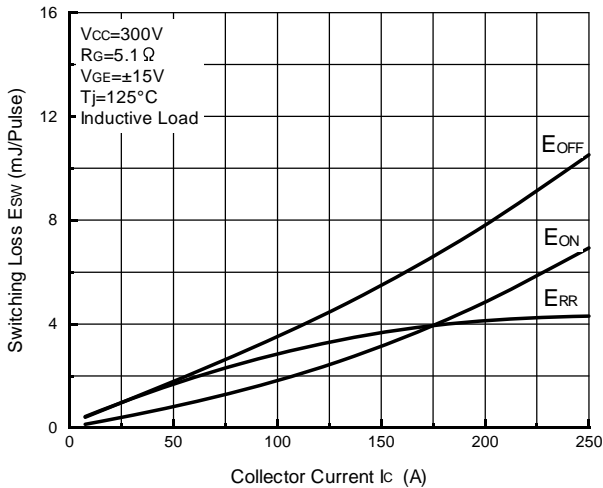

**Fig.12- Series Gate Impedance vs. Switching Loss**

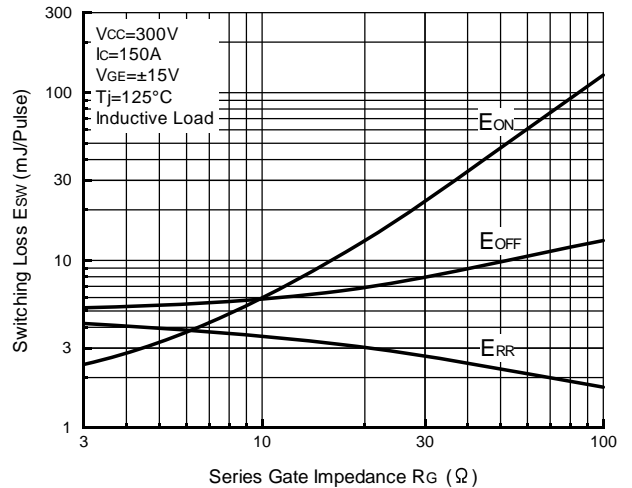

**Fig.13- Forward Characteristics of Free Wheeling Diode (Typical)**

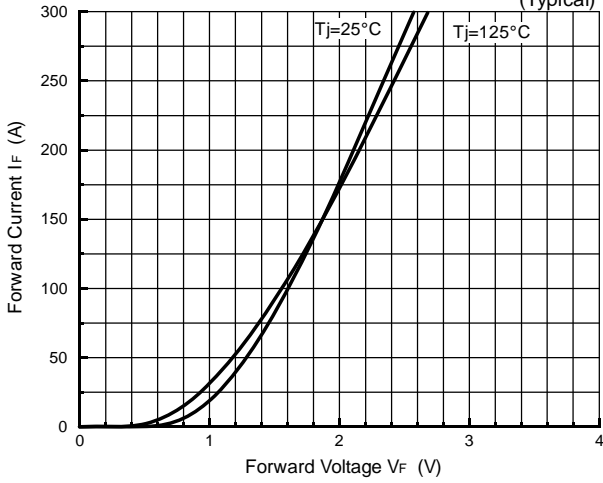

**Fig.14- Reverse Recovery Characteristics (Typical)**

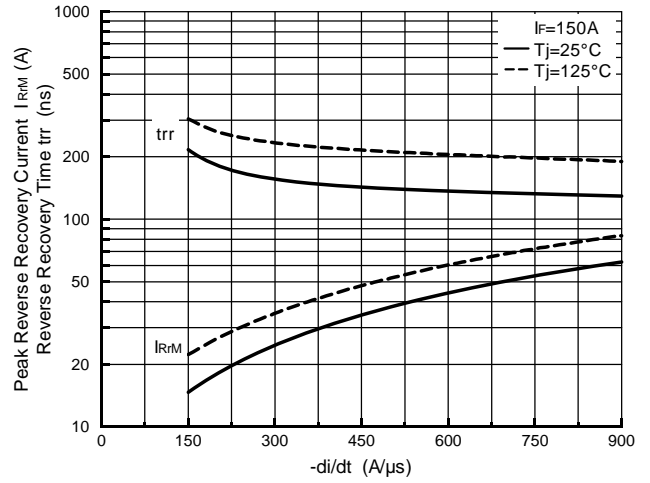

**Fig.15- Reverse Bias Safe Operating Area**

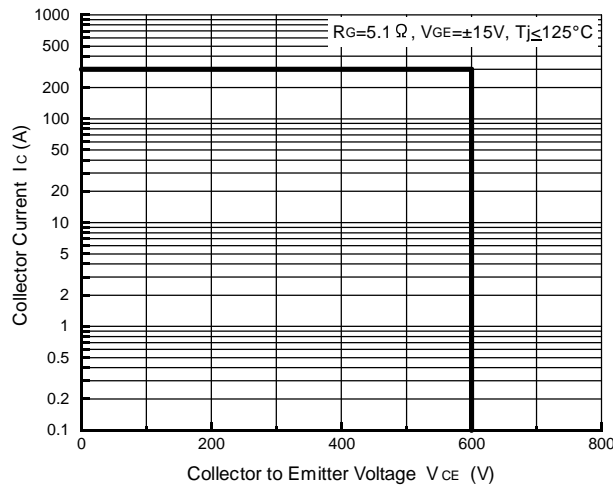

**Fig.16- Transient Thermal Impedance**

