

# THYRISTOR

## 30A Avg 1200 ~ 1600 Volts

PDT3012 PDT3016  
PDH3012 PDH3016  
PCH3012 PCH3016

### 回路図 CIRCUIT

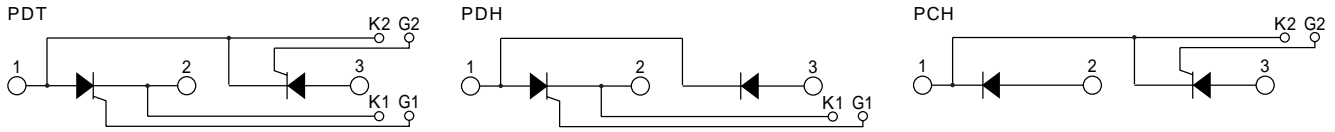

### 外形寸法図 OUTLINE DRAWING

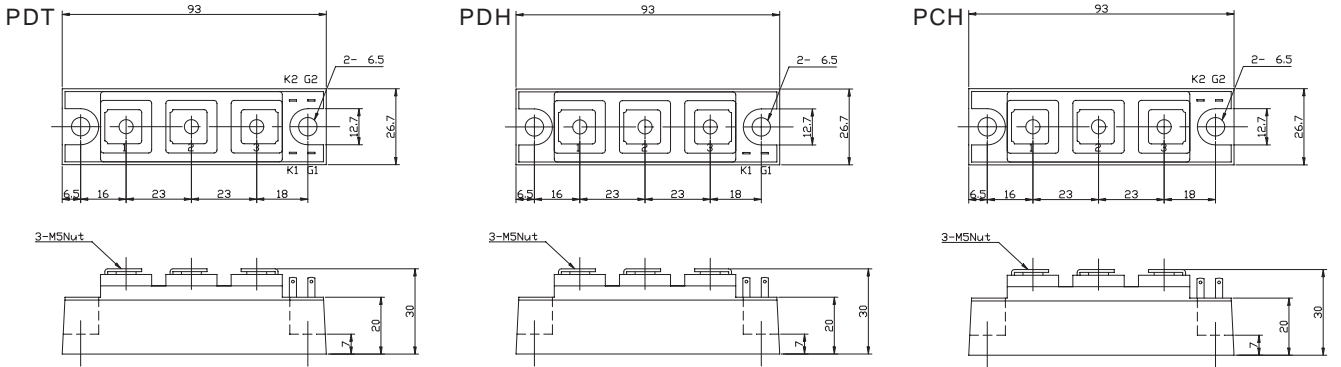

### 最大定格 Maximum Ratings

項目 Parameter	記号 Symbol	耐压クラス Grade		単位 Unit
		PDT3012/PDH3012/PCH3012	PDT3016/PDH3016/PCH3016	
くり返しピークオフ電圧 Repetitive Peak Off-State Voltage	$V_{DRM}$	1200	1600	V
非くり返しピークオフ電圧 Non Repetitive Peak Off-State Voltage	$V_{DSM}$	1300	1700	V
くり返しピーク逆電圧 Repetitive Peak Reverse Voltage	$V_{RRM}$	1200	1600	V
非くり返しピーク逆電圧 Non Repetitive Peak Reverse Voltage	$V_{RSM}$	1300	1700	V

項目 Parameter	記号 Symbol	条件 Conditions	定格値 Max. Rated Value	単位 Unit	
平均整流電流 Average Rectified Output Current	$I_{\alpha(AV)}$	商用周波数 180° 通電 Half Sine Wave $T_c = 96$	30	A	
実効オン電流 RMS On-State Current	$I_{T(RMS)}$		47	A	
サージオン電流 Surge On-State Current	$I_{TSM}$	50Hz正弦半波, 1 サイクル, 非くり返し Half Sine Wave, 1Pulse, Non-Repetitive	600	A	
電流二乗時間積 I Squared t	$I^2t$	2 ~ 10ms	1800	$A^2s$	
臨界オン電流上昇率 Critical Rate of Rise of Turned-On Current	$di/dt$	$V_D = 2/3 V_{DRM}$ , $I_{TM} = 2 \cdot I_{\alpha}$ , $T_j = 125$ $I_G = 200mA$ , $di_G/dt = 0.2A/\mu s$	100	$A/\mu s$	
ピークゲート電力損失 Peak Gate Power	$P_{GM}$		5	W	
平均ゲート電力損失 Average Gate Power	$P_{G(AV)}$		1	W	
ピークゲート電流 Peak Gate Current	$I_{GM}$		2	A	
ピークゲート電圧 Peak Gate Voltage	$V_{GM}$		10	V	
ピークゲート逆電圧 Peak Gate Reverse Voltage	$V_{RGM}$		5	V	
動作接合温度範囲 Operating Junction Temperature Range	$T_{jw}$		- 40 ~ + 125		
保存温度範囲 Storage Temperature Range	$T_{stg}$		- 40 ~ + 125		
絶縁耐圧 Isolation Voltage	$V_{iso}$	端子 - ベース間, AC 1 分間 Terminal to Base, AC 1 min.	2500	V	
締付トルク Mounting Torque	ベース部 Mounting	サーマルコンパウンド塗布 Greased	M6	2.4 ~ 3.5	N·m
	主端子部 Terminal		M5	2.4 ~ 2.8	N·m

1 アーム当りの値 Value Per 1 Arm.

電気的特性 Electrical Characteristics

項目 Parameter	記号 Symbol	条件 Conditions	特性値(最大) Maximum Value			単位 Unit
			最小 Min.	標準 Typ.	最大 Max.	
ピークオフ電流 Peak Off-State Current	$I_{DM}$	$T_j=125$ , $V_{DM}=V_{DRM}$			10	mA
ピーク逆電流 Peak Reverse Current	$I_{RM}$	$T_j=125$ , $V_{RM}=V_{RRM}$			10	mA
ピークオン電圧 Peak On-State Voltage	$V_{TM}$	$T_j=25$ , $I_{TM}=90A$			1.5	V
トリガゲート電流 Gate Current to Trigger	$I_{GT}$	$V_D=6V$ , $I_T=1A$	$T_j=-40$		200	mA
			$T_j=25$		100	mA
			$T_j=125$		50	mA
トリガゲート電圧 Gate Voltage to Trigger	$V_{GT}$	$V_D=6V$ , $I_T=1A$	$T_j=-40$		4	V
			$T_j=25$		2.5	V
			$T_j=125$		2	V
非トリガゲート電圧 Gate Non-Trigger Voltage	$V_{GD}$	$T_j=125$ , $V_D=2/3V_{DRM}$	0.25			V
臨界オフ電圧上昇率 Critical Rate of Rise of Off-State Voltage	$dv/dt$	$T_j=125$ , $V_D=2/3V_{DRM}$	500			V/ $\mu$ s
ターンオフ時間 Turn-Off Time	$t_q$	$T_j=125$ , $I_{TM}=I_o$ , $V_D=2/3V_{DRM}$ $dv/dt=20V/\mu$ s , $V_R=100V$ , $-di/dt=20A/\mu$ s		100		$\mu$ s
ターンオン時間 Turn-On Time	$t_{gt}$			6		$\mu$ s
遅れ時間 Delay Time	$t_d$	$T_j=25$ , $V_D=2/3V_{DRM}$ $I_G=200mA$ , $di/dt=0.2A/\mu$ s		2		$\mu$ s
立上がり時間 Rise Time	$t_r$			4		$\mu$ s
ラッチング電流 Latching Current	$I_L$	$T_j=25$		100		mA
保持電流 Holding Current	$I_H$	$T_j=25$		50		mA
熱抵抗 Thermal Resistance	$R_{th(j-c)}$	接合部 - ケース間 Junction to Case			0.7	/W
接触熱抵抗 Thermal Resistance	$R_{th(c-f)}$	ケース - フィン間, サーマルコンパウンド塗布 Case to Fin, Greased			0.2	/W

質量...約155g  
Approximate Weight

1 アーム当りの値 Value Per 1 Arm.

オン電圧特性  
ON-STATE CURRENT VS. VOLTAGE

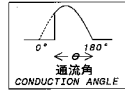
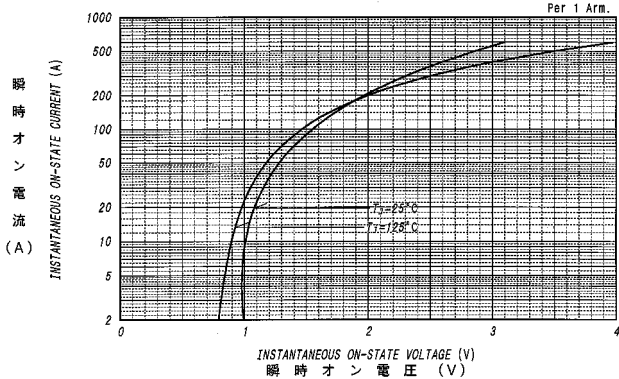

平均オン電力損失特性  
AVERAGE ON-STATE POWER DISSIPATION  
for SINUSOIDAL CURRENT WAVEFORM

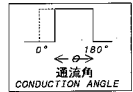
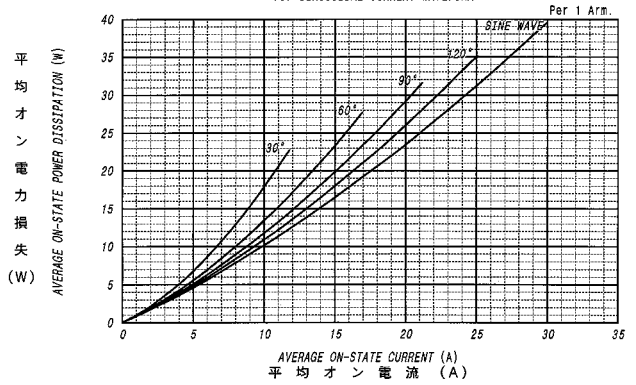

平均オン電力損失特性  
AVERAGE ON-STATE POWER DISSIPATION  
for RECTANGULAR CURRENT WAVEFORM

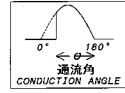
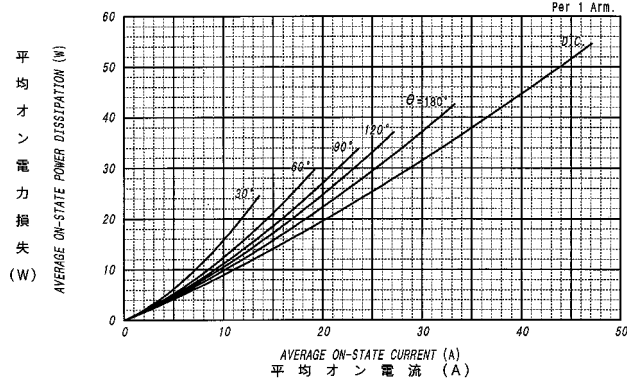

平均オン電流 - ケース温度定格  
AVERAGE ON-STATE CURRENT VS. CASE TEMPERATURE

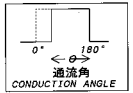
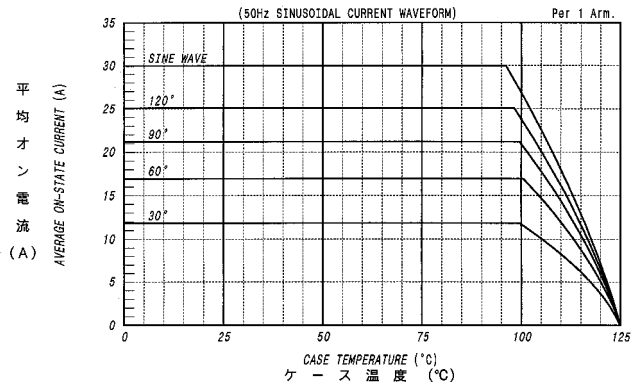

平均オン電流 - ケース温度定格  
AVERAGE ON-STATE CURRENT VS. CASE TEMPERATURE

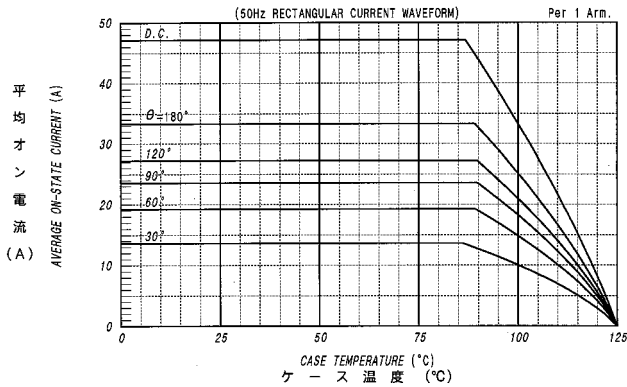

サージオン電流定格  
SURGE CURRENT RATINGS

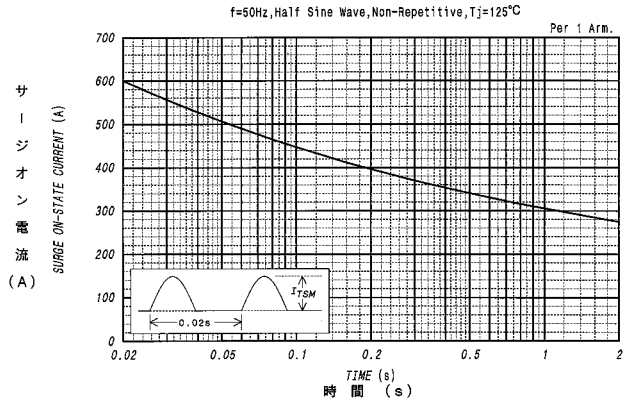

ゲート特性  
GATE CHARACTERISTICS

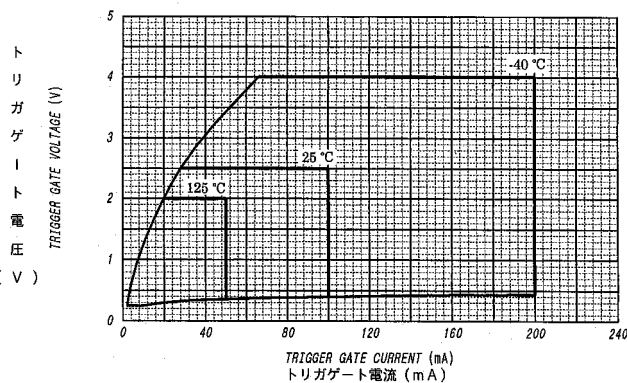

ゲート定格  
GATE RATINGS

