

回路図 : **CIRCUIT**

外形寸法図 : **OUTLINE DRAWING**

Dimension: [mm]

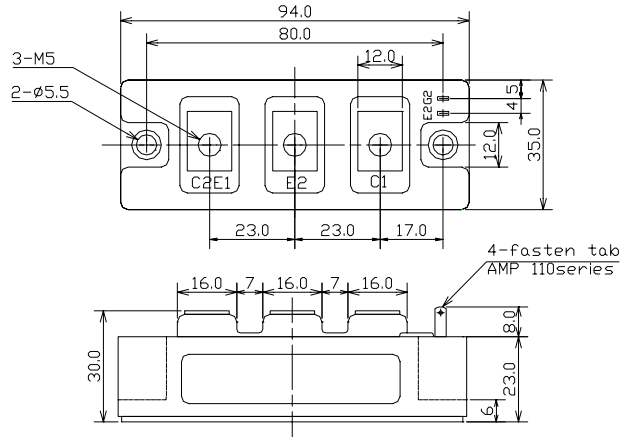
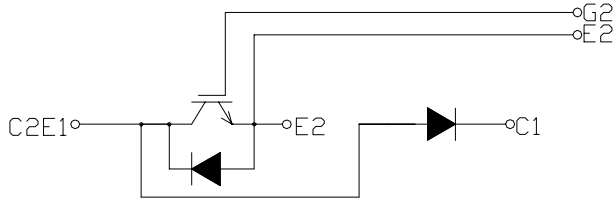

最大定格 : **MAXIMUM RATINGS** ($T_c = 25$)

重量 : 220 g

Item	Symbol	Rated Value	Unit
コレクタ・エミッタ間電圧 Collector-Emitter Voltage	V_{CES}	600	V
ゲート・エミッタ間電圧 Gate-Emitter Voltage	V_{GES}	± 20	V
コレクタ電流 Collector Current	I_C	DC	100
		1ms	200
コレクタ損失 Collector Power Dissipation	P_C	400	W
接合温度 Junction Temperature Range	T_j	-40 ~ +150	
保存温度 Storage Temperature Range	T_{stg}	-40 ~ +125	
絶縁耐圧(Terminal to Base AC,1minute) Isolation Voltage	V_{iso}	2,500	V (RMS)
締め付けトルク Mounting Torque	F_{tor}	Module Base to Heatsink	2 (20.4)
		Busbar to Main Terminal	

電気的特性 : **ELECTRICAL CHARACTERISTICS** ($T_c = 25$)

Characteristic	Symbol	Test Condition	Min.	Typ.	Max.	Unit
コレクタ遮断電流 Collector-Emitter Cut-Off Current	I_{CES}	$V_{CE} = 600V, V_{GE} = 0V$	-	-	1.0	mA
ゲート漏れ電流 Gate-Emitter Leakage Current	I_{GES}	$V_{GE} = \pm 20V, V_{CE} = 0V$	-	-	1.0	μA
コレクタ・エミッタ間飽和電圧 Collector-Emitter Saturation Voltage	$V_{CE(sat)}$	$I_C = 100A, V_{GE} = 15V$	-	2.1	2.6	V
ゲートしきい値電圧 Gate-Emitter Threshold Voltage	$V_{GE(th)}$	$V_{CE} = 5V, I_C = 100mA$	4.0	-	8.0	V
入力容量 Input Capacitance	C_{ies}	$V_{CES} = 10V, V_{GE} = 0V, f = 1MHz$	-	10,000	-	pF
スイッチング時間 Switching Time	上昇時間 Rise Time	$V_{CC} = 300V$ $R_L = 3$ $R_G = 7.5$ $V_{GE} = \pm 15V$	-	0.15	0.30	μs
	ターンオン時間 Turn-on Time		-	0.25	0.40	
	下降時間 Fall Time		-	0.20	0.35	
	ターンオフ時間 Turn-off Time		-	0.45	0.70	

フリーホイールダイオードの特性 : **FREE WHEELING DIODE RATINGS & CHARACTERISTICS** ($T_c = 25$)

Item	Symbol	Rated Value	Unit
順電流 Forward Current	I_F	DC	100
		1ms	200

Characteristic	Symbol	Test Condition	Min.	Typ.	Max.	Unit
順電圧 Peak Forward Voltage	V_F	$I_F = 100A, V_{GE} = 0V$	-	1.9	2.4	V
逆回復時間 Reverse Recovery Time	t_{rr}	$I_F = 100A, V_{GE} = -10V$ $di/dt = 100A/\mu s$	-	0.15	0.25	μs

熱的特性 : **THERMAL CHARACTERISTICS**

Characteristic	Symbol	Test Condition	Min.	Typ.	Max.	Unit
熱抵抗 Thermal Impedance	$R_{th(j-c)}$	IGBT	-	-	0.31	/W
		Diode	-	-	0.65	

PRHMB100A6A

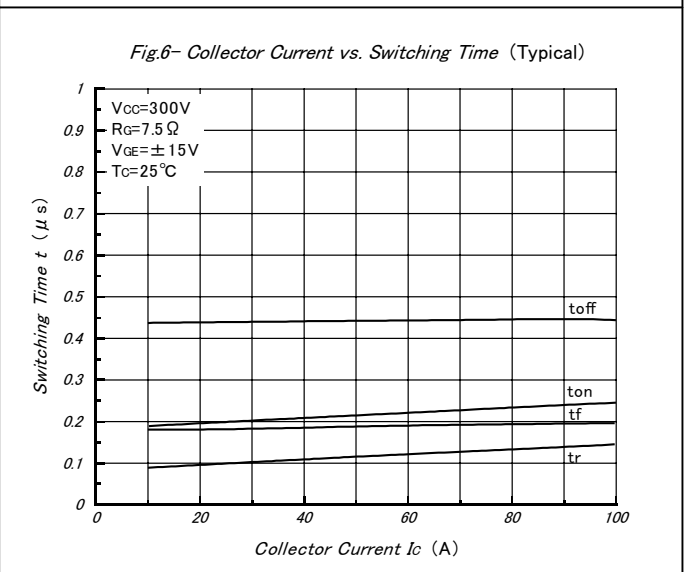
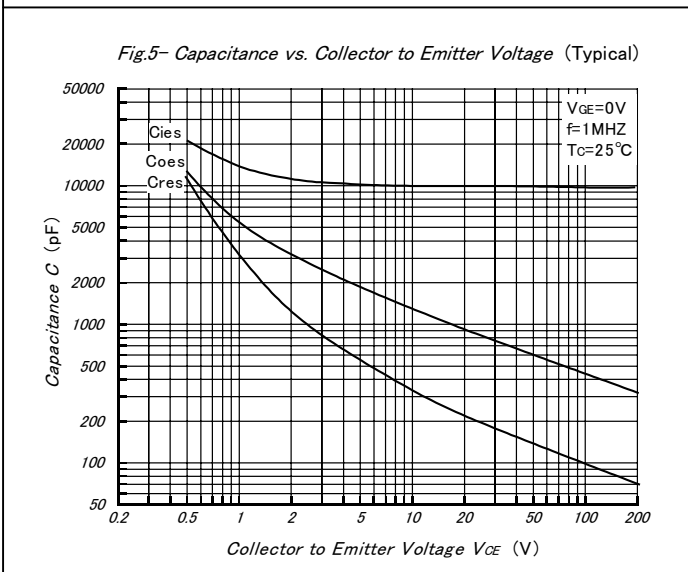
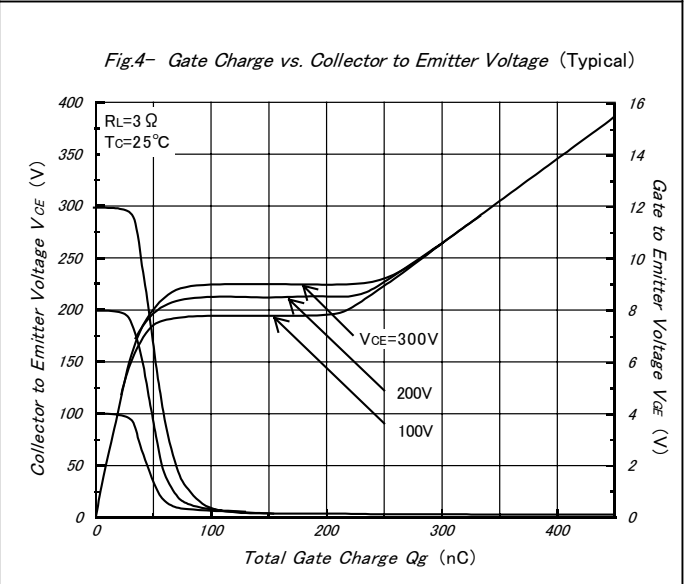
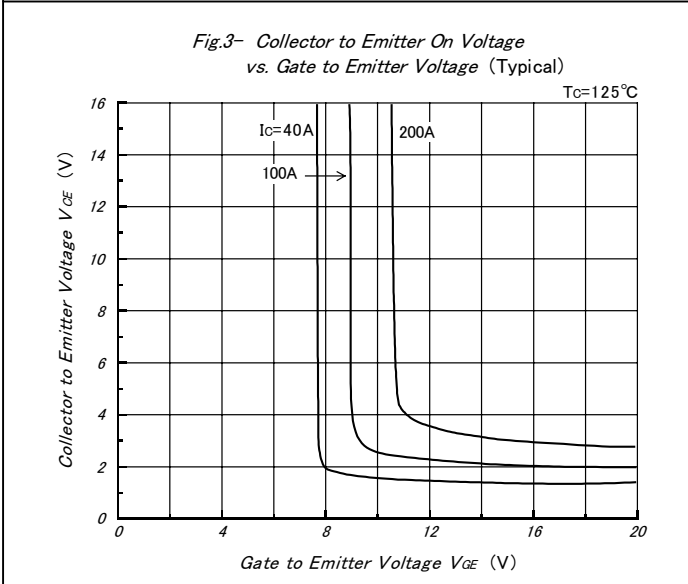
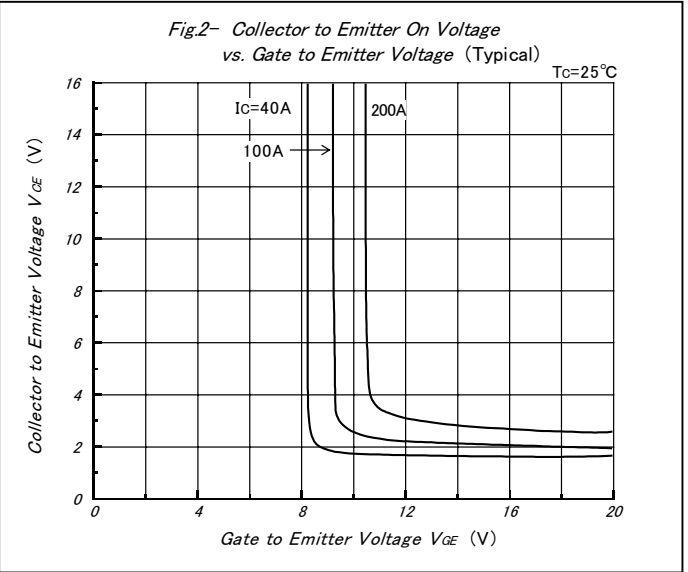
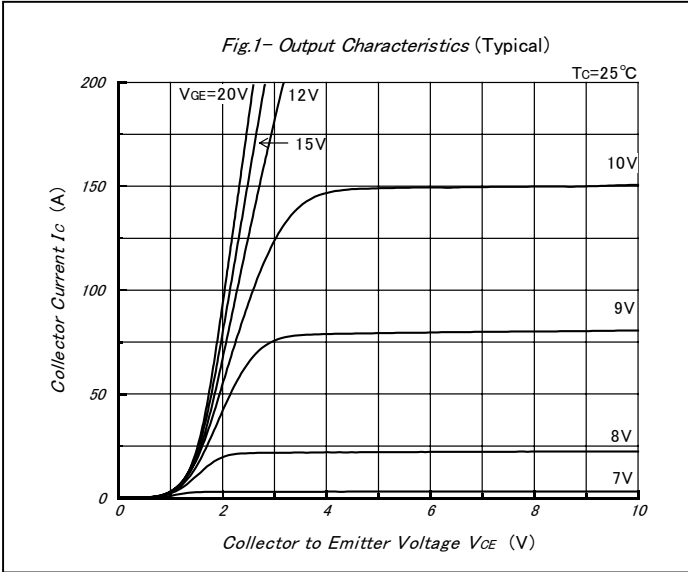

PRHMB100A6A

Fig.7- Series Gate Impedance vs. Switching Time (Typical)

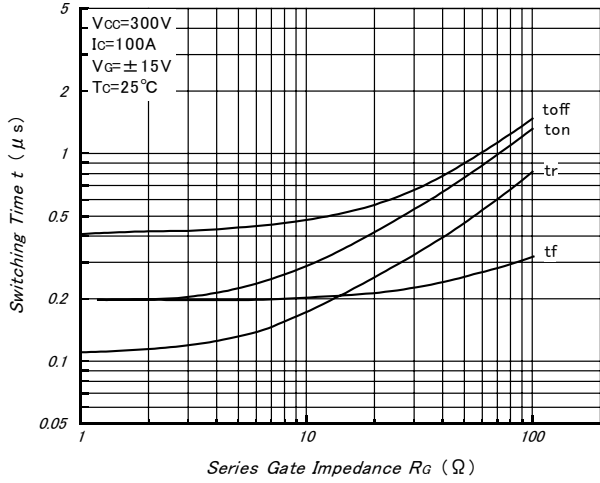

Fig.8- Forward Characteristics of Free Wheeling Diode (Typical)

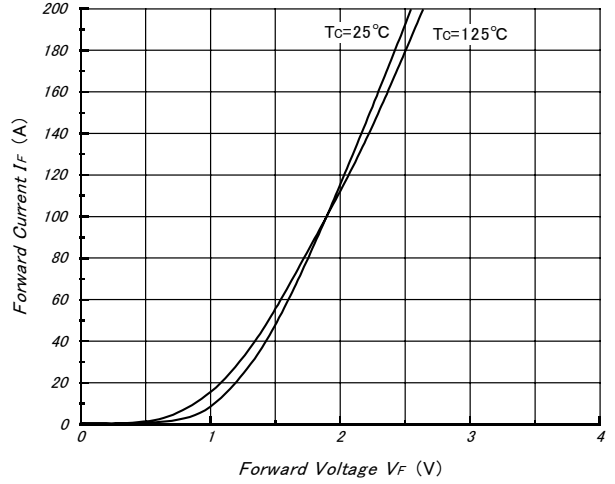

Fig.9- Reverse Recovery Characteristics (Typical)

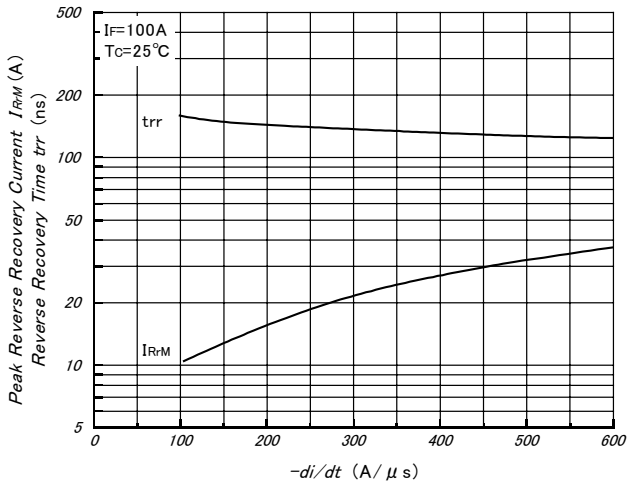

Fig.10- Reverse Bias Safe Operating Area (Typical)

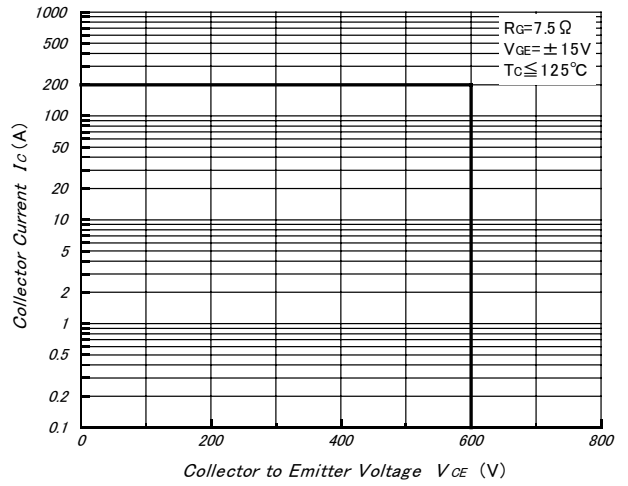

Fig.11- Transient Thermal Impedance

