

回路図 : **CIRCUIT**

外形寸法図 : **OUTLINE DRAWING**

Dimension: [ mm ]

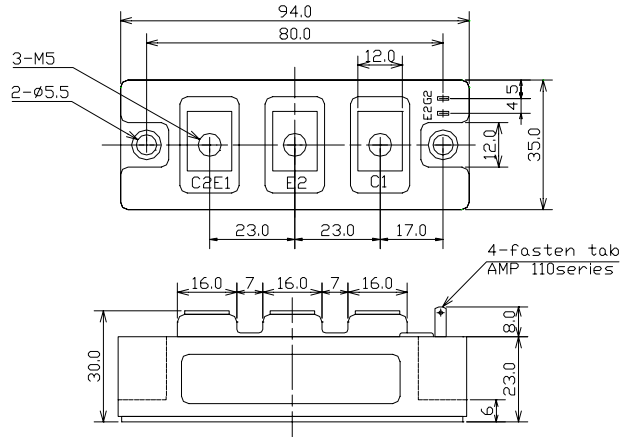
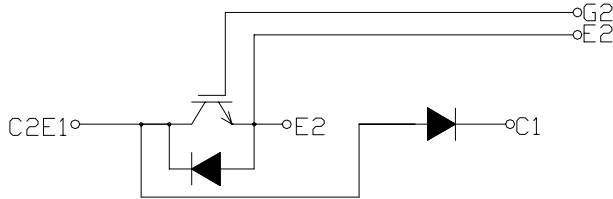

最大定格 : **MAXIMUM RATINGS** ( $T_c = 25$ )

重量 : 220 g

Item	Symbol	Rated Value	Unit
コレクタ・エミッタ間電圧 Collector-Emitter Voltage	$V_{CES}$	600	V
ゲート・エミッタ間電圧 Gate-Emitter Voltage	$V_{GES}$	$\pm 20$	V
コレクタ電流 Collector Current	$I_C$	DC	150
		1ms	300
コレクタ損失 Collector Power Dissipation	$P_C$	560	W
接合温度 Junction Temperature Range	$T_j$	-40 ~ +150	
保存温度 Storage Temperature Range	$T_{stg}$	-40 ~ +125	
絶縁耐圧 (Terminal to Base AC, 1minute) Isolation Voltage	$V_{iso}$	2,500	V (RMS)
締め付けトルク Mounting Torque	$F_{tor}$	Module Base to Heatsink	2 (20.4)
		Busbar to Main Terminal	

電気的特性 : **ELECTRICAL CHARACTERISTICS** ( $T_c = 25$ )

Characteristic	Symbol	Test Condition	Min.	Typ.	Max.	Unit
コレクタ遮断電流 Collector-Emitter Cut-Off Current	$I_{CES}$	$V_{CE} = 600V, V_{GE} = 0V$	-	-	2.0	mA
ゲート漏れ電流 Gate-Emitter Leakage Current	$I_{GES}$	$V_{GE} = \pm 20V, V_{CE} = 0V$	-	-	1.0	$\mu A$
コレクタ・エミッタ間飽和電圧 Collector-Emitter Saturation Voltage	$V_{CE(sat)}$	$I_C = 150A, V_{GE} = 15V$	-	2.1	2.6	V
ゲートしきい値電圧 Gate-Emitter Threshold Voltage	$V_{GE(th)}$	$V_{CE} = 5V, I_C = 150mA$	4.0	-	8.0	V
入力容量 Input Capacitance	$C_{ies}$	$V_{CES} = 10V, V_{GE} = 0V, f = 1MHz$	-	15,000	-	pF
スイッチング時間 Switching Time	上昇時間 Rise Time	$V_{CC} = 300V$ $R_L = 2\Omega$ $R_G = 5.1\Omega$ $V_{GE} = \pm 15V$	-	0.15	0.30	$\mu s$
	ターンオン時間 Turn-on Time		-	0.25	0.40	
	下降時間 Fall Time		-	0.20	0.35	
	ターンオフ時間 Turn-off Time		-	0.45	0.70	

フリーホイールダイオードの特性 : **FREE WHEELING DIODE RATINGS & CHARACTERISTICS** ( $T_c = 25$ )

Item	Symbol	Rated Value	Unit
順電流 Forward Current	$I_F$	DC	150
		1ms	300

Characteristic	Symbol	Test Condition	Min.	Typ.	Max.	Unit
順電圧 Peak Forward Voltage	$V_F$	$I_F = 150A, V_{GE} = 0V$	-	1.9	2.4	V
逆回復時間 Reverse Recovery Time	$t_{rr}$	$I_F = 150A, V_{GE} = -10V$ $di/dt = 150A/\mu s$	-	0.15	0.25	$\mu s$

熱的特性 : **THERMAL CHARACTERISTICS**

Characteristic	Symbol	Test Condition	Min.	Typ.	Max.	Unit
熱抵抗 Thermal Impedance	$R_{th(j-c)}$	IGBT	-	-	0.22	/W
		Diode	-	-	0.45	

# PRHMB150A6A

Fig.1- Output Characteristics (Typical)

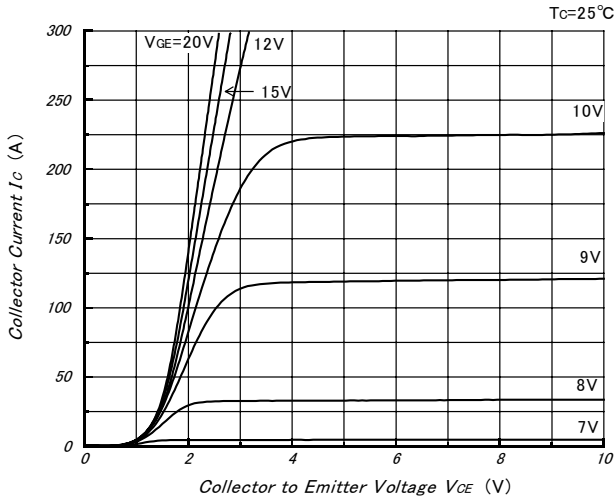

Fig.2- Collector to Emitter On Voltage vs. Gate to Emitter Voltage (Typical)

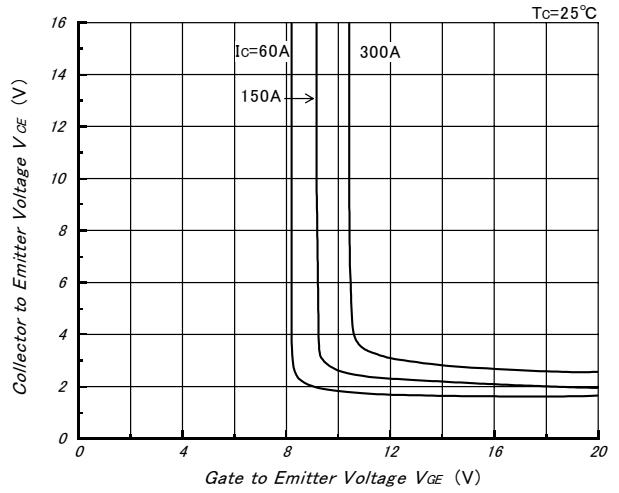

Fig.3- Collector to Emitter On Voltage vs. Gate to Emitter Voltage (Typical)

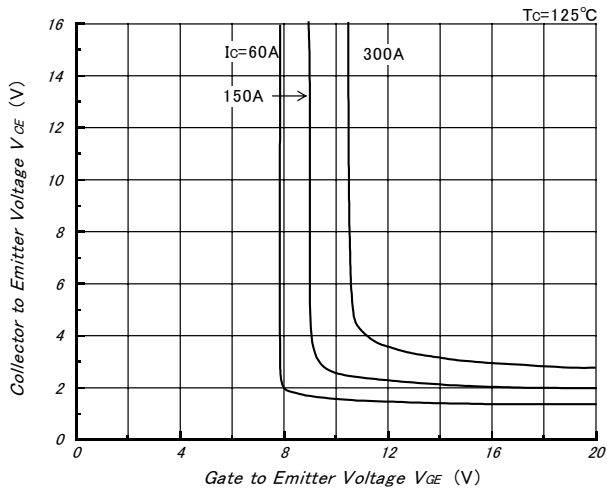

Fig.4- Gate Charge vs. Collector to Emitter Voltage (Typical)

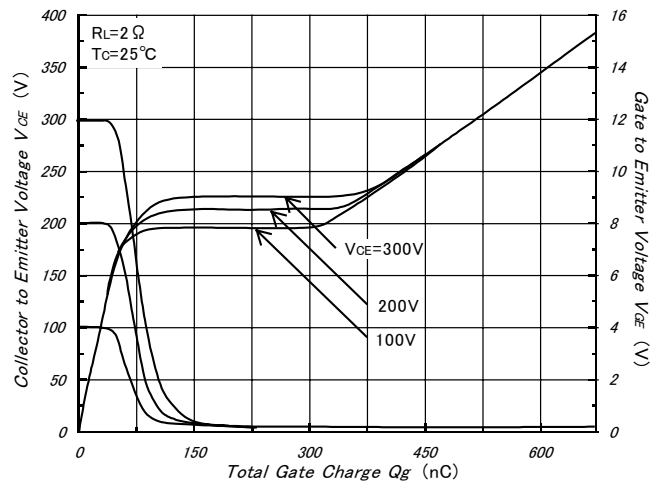

Fig.5- Capacitance vs. Collector to Emitter Voltage (Typical)

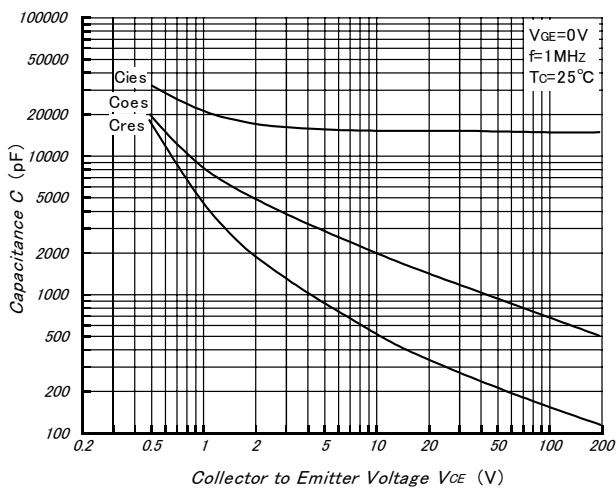
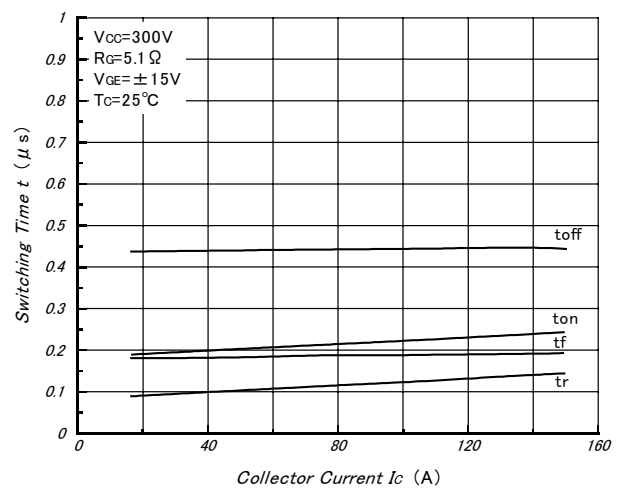

Fig.6- Collector Current vs. Switching Time (Typical)



PRHMB150A6A

Fig.7- Series Gate Impedance vs. Switching Time (Typical)

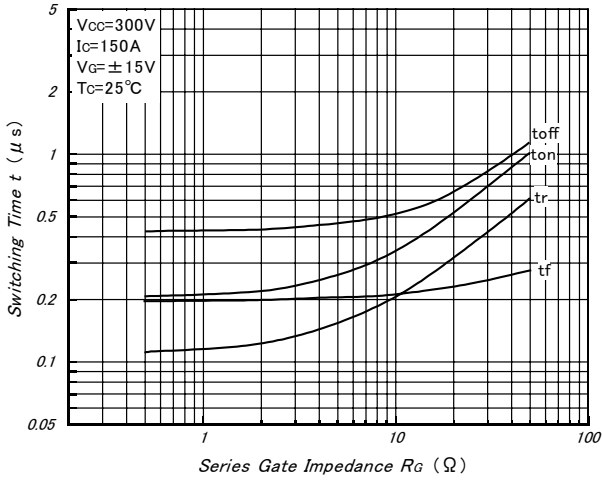

Fig.8- Forward Characteristics of Free Wheeling Diode (Typical)

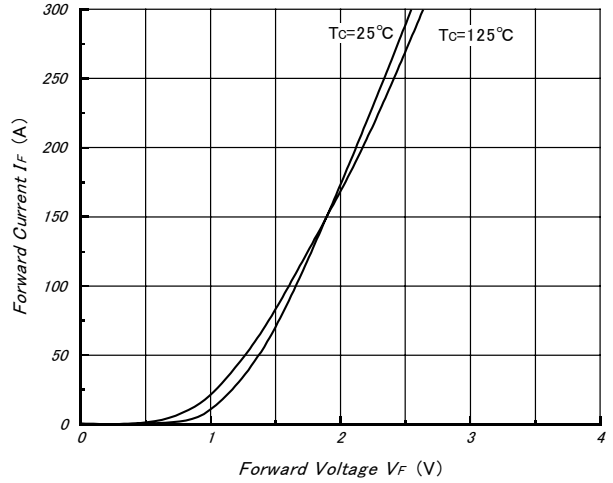

Fig.9- Reverse Recovery Characteristics (Typical)

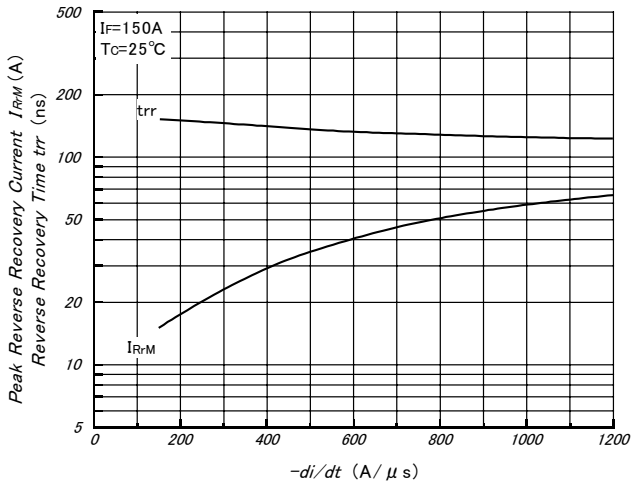

Fig.10- Reverse Bias Safe Operating Area (Typical)

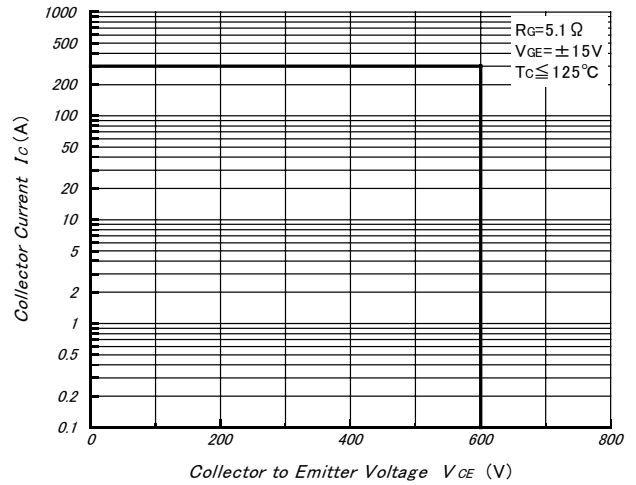

Fig.11- Transient Thermal Impedance

