

□ 回路図 : *CIRCUIT*

□ 外形寸法図 : *OUTLINE DRAWING*

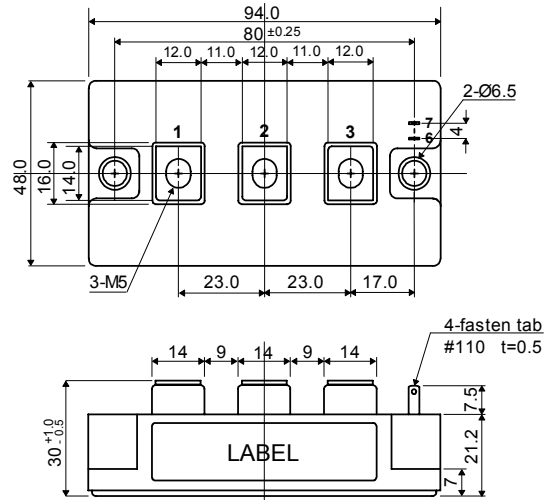
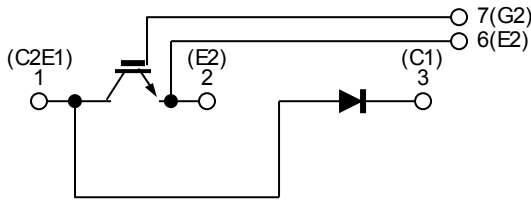

Dimension: [mm]

□ 最大定格 : *MAXIMUM RATINGS* ( $T_c=25^\circ\text{C}$ )

Item	Symbol	Rated Value	Unit
コレクタ・エミッタ間電圧 Collector-Emitter Voltage	$V_{CES}$	1, 200	V
ゲート・エミッタ間電圧 Gate-Emitter Voltage	$V_{GES}$	$\pm 20$	V
コレクタ電流 Collector Current	DC	$I_C$	150
	1ms	$I_{CP}$	300
コレクタ損失 Collector Power Dissipation	$P_C$	730	W
接合温度 Junction Temperature Range	$T_j$	$-40 \sim +150$	$^\circ\text{C}$
保存温度 Storage Temperature Range	$T_{stg}$	$-40 \sim +125$	$^\circ\text{C}$
絶縁耐圧(Terminal to Base AC, 1 minute) Isolation Voltage	$V_{ISO}$	2,500	V (RMS)
締め付けトルク Mounting Torque	Module Base to Heatsink	$F_{tor}$	3 (30.6)
	Busbar to Main Terminal		2 (20.4)

□ 電気的特性 : *ELECTRICAL CHARACTERISTICS* ( $T_c=25^\circ\text{C}$ )

Characteristic	Symbol	Test Condition	Min.	Tvp.	Max.	Unit
コレクタ遮断電流 Collector-Emitter Cut-Off Current	$I_{CES}$	$V_{CE} = 1200V, V_{GE} = 0V$	-	-	3.0	mA
ゲート漏れ電流 Gate-Emitter Leakage Current	$I_{GES}$	$V_{GE} = \pm 20V, V_{CE} = 0V$	-	-	1.0	$\mu\text{A}$
コレクタ・エミッタ間飽和電圧 Collector-Emitter Saturation Voltage	$V_{CE(sat)}$	$I_C = 150A, V_{GE} = 15V$	-	1.9	2.4	V
ゲートしきい値電圧 Gate-Emitter Threshold Voltage	$V_{GE(th)}$	$V_{CE} = 5V, I_C = 150mA$	4.0	-	8.0	V
入力容量 Input Capacitance	$C_{ies}$	$V_{CE} = 10V, V_{GE} = 0V, f = 1MHz$	-	12,600	-	pF
スイッチング時間 Switching Time	上昇時間 Rise Time	$V_{CC} = 600V$ $R_L = 4\Omega$ $R_G = 3.6\Omega$ $V_{GE} = \pm 15V$	-	0.25	0.45	$\mu\text{s}$
	ターンオン時間 Turn-on Time		-	0.40	0.70	
	下降時間 Fall Time		-	0.25	0.35	
	ターンオフ時間 Turn-off Time		-	0.80	1.10	

□ フリーホイールダイオードの特性 : *FREE WHEELING DIODE RATINGS & CHARACTERISTICS* ( $T_c=25^\circ\text{C}$ )

Item	Symbol	Rated Value	Unit
順電流 Forward Current	DC	$I_F$	150
	1ms	$I_{FM}$	300

Characteristic	Symbol	Test Condition	Min.	Tvp.	Max.	Unit
順電圧 Peak Forward Voltage	$V_F$	$I_F = 150A, V_{GE} = 0V$	-	1.9	2.4	V
逆回復時間 Reverse Recovery Time	$t_{rr}$	$I_F = 150A, V_{GE} = -10V$ $di/dt = 300A/\mu\text{s}$	-	0.2	0.3	$\mu\text{s}$

□ 熱的特性 : *THERMAL CHARACTERISTICS*

Characteristic	Symbol	Test Condition	Min.	Tvp.	Max.	Unit
熱抵抗 Thermal Impedance	IGBT	Junction to Case	-	-	0.16	$^\circ\text{C}/\text{W}$
	Diode		-	-	0.32	

Fig.1- Output Characteristics (Typical)

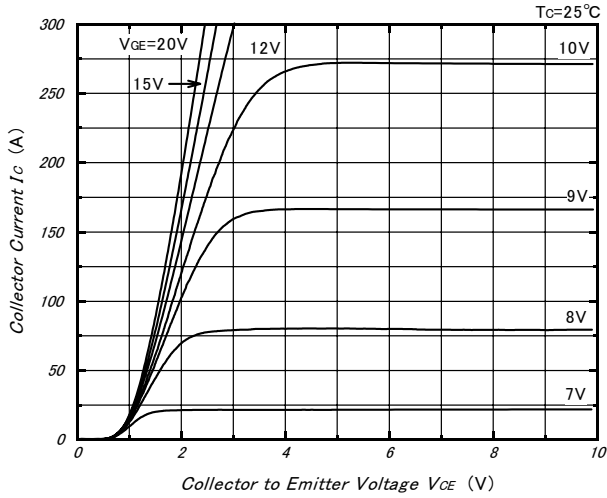

Fig.2- Collector to Emitter On Voltage vs. Gate to Emitter Voltage (Typical)

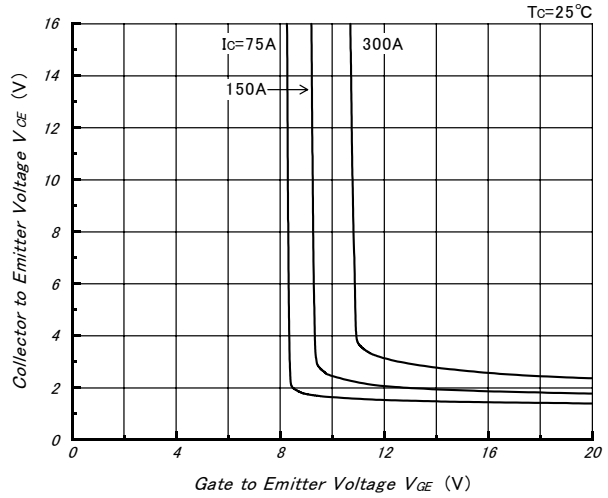

Fig.3- Collector to Emitter On Voltage vs. Gate to Emitter Voltage (Typical)

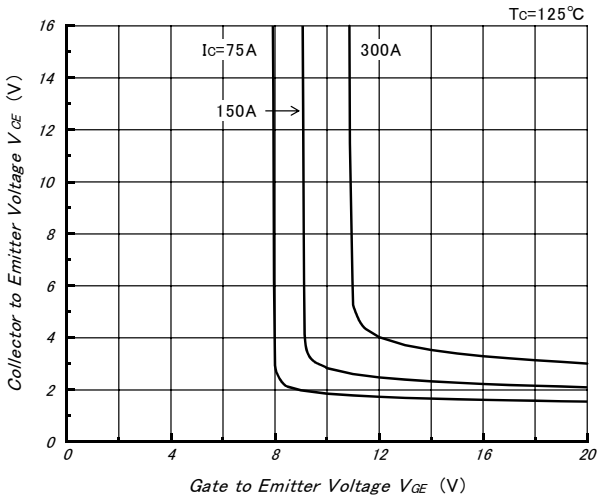

Fig.4- Gate Charge vs. Collector to Emitter Voltage (Typical)

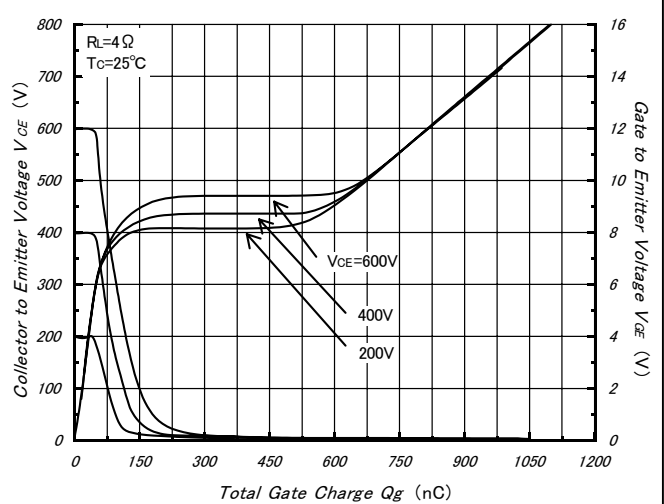

Fig.5- Capacitance vs. Collector to Emitter Voltage (Typical)

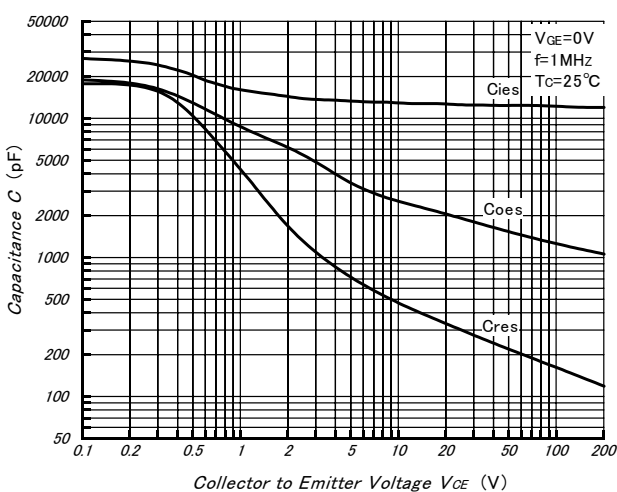

Fig.6- Collector Current vs. Switching Time (Typical)

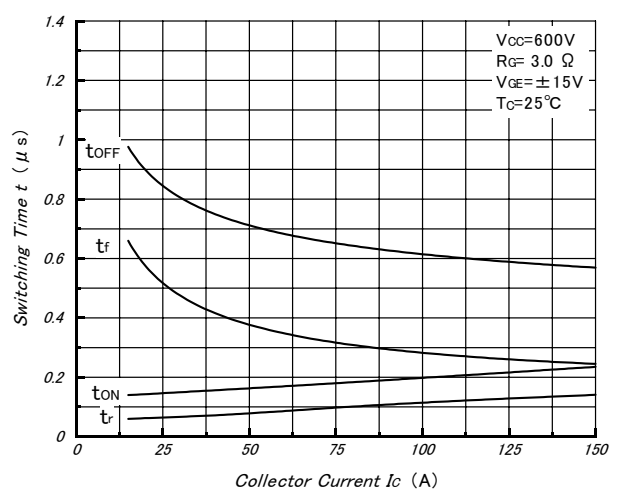

Fig.7- Series Gate Impedance vs. Switching Time (Typical)

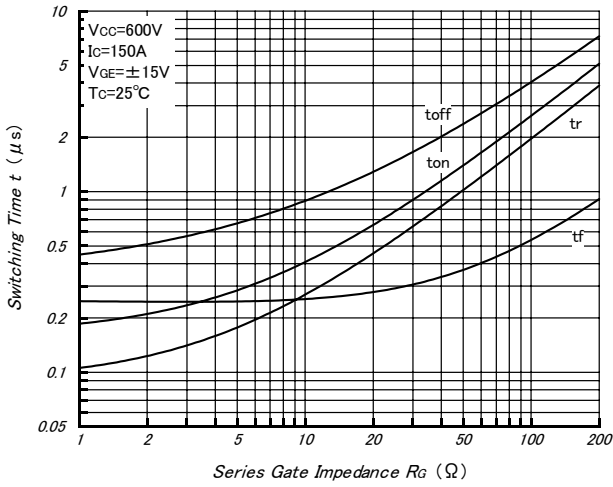

Fig.8- Forward Characteristics of Free Wheeling Diode (Typical)

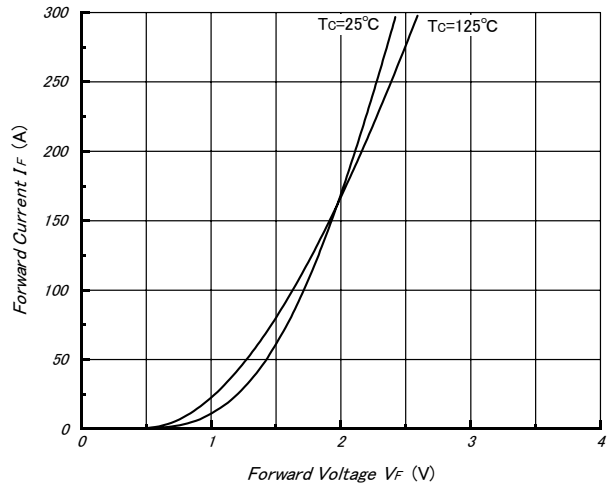

Fig.9- Reverse Recovery Characteristics (Typical)

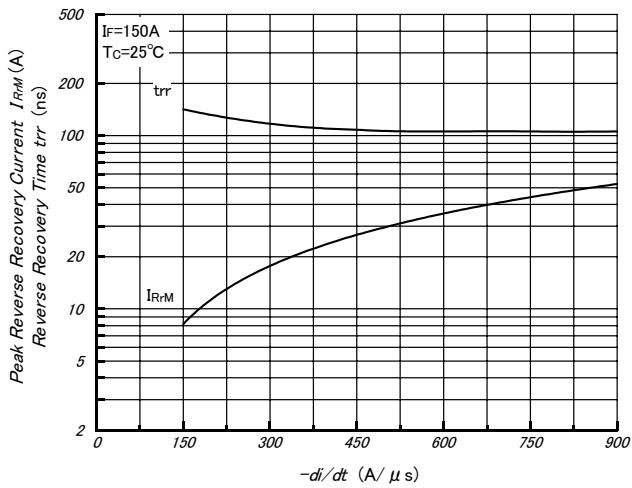

Fig.10- Reverse Bias Safe Operating Area

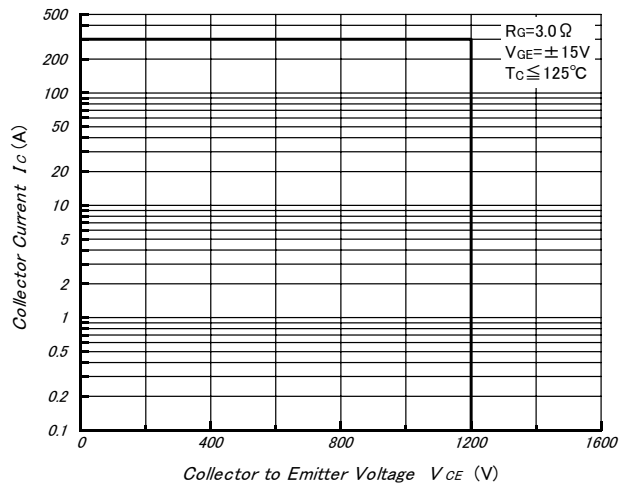

Fig.11- Transient Thermal Impedance

