

□ 回路図 : **CIRCUIT**

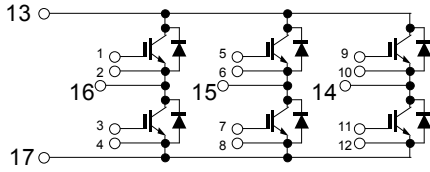

□ 外形寸法図 : **OUTLINE DRAWING**

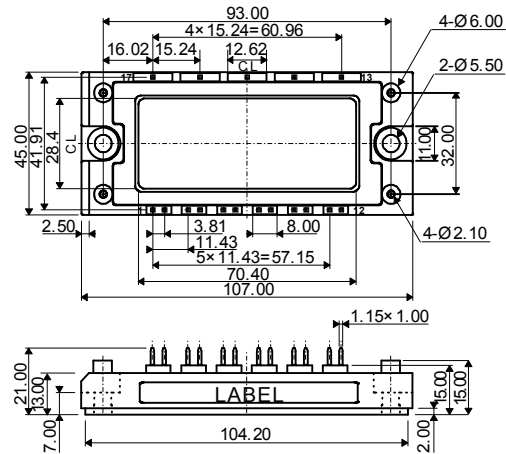

Dimension: [mm]

□ 最大定格 : **MAXIMUM RATINGS** (at $T_c=25^\circ\text{C}$ unless otherwise specified)

Item	Symbol	Rated Value	Unit
コレクタ・エミッタ間電圧 Collector-Emitter Voltage	V_{CES}	600	V
ゲート・エミッタ間電圧 Gate-Emitter Voltage	V_{GES}	± 20	V
コレクタ電流 Collector Current	DC	50	A
	1ms	100	
コレクタ損失 Collector Power Dissipation	P_c	250	W
接合温度 Junction Temperature Range	T_j	$-40 \sim +150$	$^\circ\text{C}$
保存温度 Storage Temperature Range	T_{stg}	$-40 \sim +125$	$^\circ\text{C}$
絶縁耐圧 (Terminal to Base AC, 1minute) Isolation Voltage	V_{iso}	2,500	V(RMS)
締め付けトルク Mounting Torque	Module Base to Heatsink	2 (20.4)	N·m (kgf·cm)
	Busbar to Main Terminal		

□ 電気的特性 : **ELECTRICAL CHARACTERISTICS** (at $T_j=25^\circ\text{C}$ unless otherwise specified)

Characteristic	Symbol	Test Condition	Min.	Typ.	Max.	Unit
コレクタ遮断電流 Collector-Emitter Cut-Off Current	I_{CES}	$V_{CE} = 600\text{V}, V_{GE} = 0\text{V}$	—	—	1.0	mA
ゲート漏れ電流 Gate-Emitter Leakage Current	I_{GES}	$V_{GE} = \pm 20\text{V}, V_{CE} = 0\text{V}$	—	—	1.0	μA
コレクタ・エミッタ間飽和電圧 Collector-Emitter Saturation Voltage	$V_{CE(sat)}$	$I_c = 50\text{A}, V_{GE} = 15\text{V}$	—	2.1	2.6	V
ゲートしきい値電圧 Gate-Emitter Threshold Voltage	$V_{GE(th)}$	$V_{CE} = 5\text{V}, I_c = 50\text{mA}$	4.0	—	8.0	V
入力容量 Input Capacitance	C_{ies}	$V_{CE} = 10\text{V}, V_{GE} = 0\text{V}, f = 1\text{MHz}$	—	2,500	—	pF
スイッチング時間 Switching Time	上昇時間 Rise Time	$V_{cc} = 300\text{V}$ $R_L = 6.0\Omega$ $R_G = 20\Omega$ $V_{GE} = \pm 15\text{V}$	—	0.15	0.30	μs
	ターンオン時間 Turn-on Time		—	0.25	0.40	
	下降時間 Fall Time		—	0.10	0.35	
	ターンオフ時間 Turn-off Time		—	0.35	0.70	

□ フリーホイーリングダイオードの特性 : **FREE WHEELING DIODE RATINGS** (at $T_c=25^\circ\text{C}$) & **CHARACTERISTICS** (at $T_j=25^\circ\text{C}$)

Item	Symbol	Rated Value	Unit
順電流 Forward Current	DC	50	A
	1ms	100	

Characteristic	Symbol	Test Condition	Min.	Typ.	Max.	Unit
順電圧 Peak Forward Voltage	V_F	$I_F = 50\text{A}, V_{GE} = 0\text{V}$	—	1.9	2.4	V
逆回復時間 Reverse Recovery Time	t_{rr}	$I_F = 50\text{A}, V_{GE} = -10\text{V}$ $di/dt = 100\text{A}/\mu\text{s}$	—	0.15	0.25	μs

□ 熱的特性 : **THERMAL CHARACTERISTICS**

Characteristic	Symbol	Test Condition	Min.	Typ.	Max.	Unit
熱抵抗 Thermal Impedance	IGBT	Junction to Case (T_c チップ直下での測定点)	—	—	0.50	$^\circ\text{C}/\text{W}$
	Diode		—	—	1.10	

Fig.1- Output Characteristics (Typical)

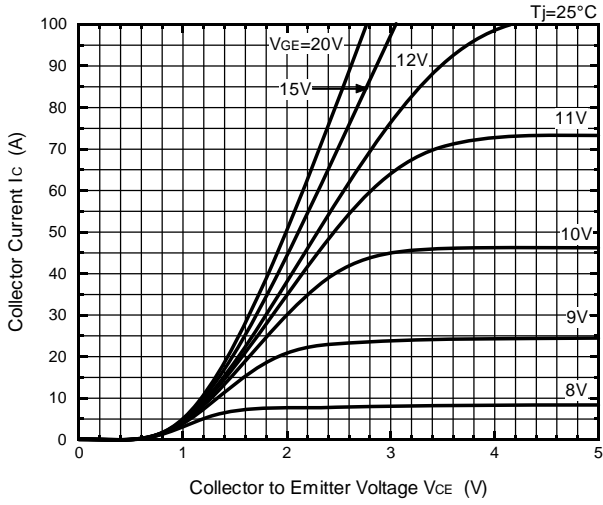

Fig.2- Output Characteristics (Typical)

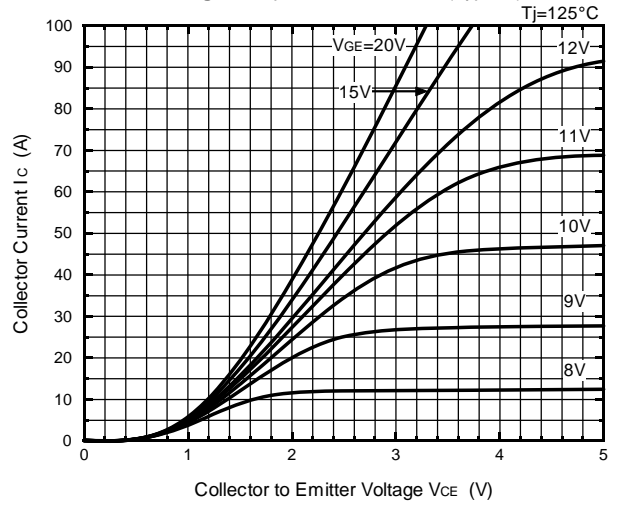

Fig.3- Collector to Emitter On Voltage vs. Gate to Emitter Voltage (Typical)

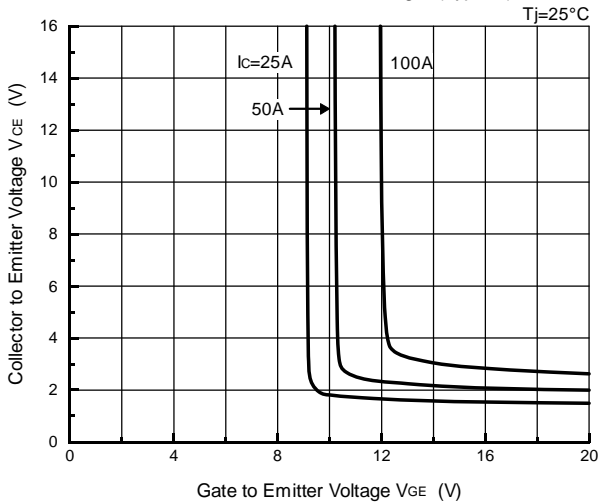

Fig.4- Collector to Emitter On Voltage vs. Gate to Emitter Voltage (Typical)

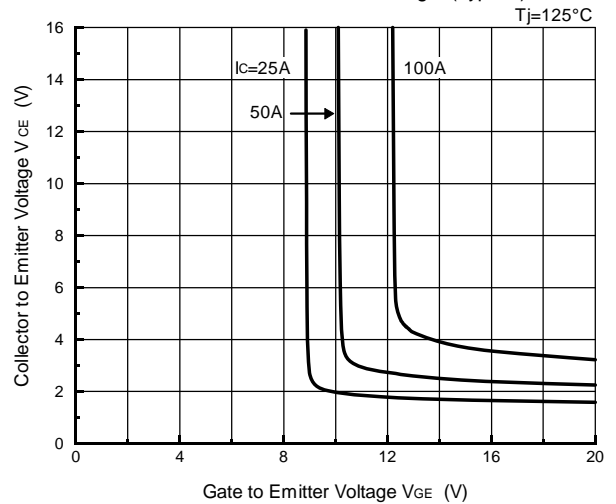

Fig.5- Gate Charge vs. Collector to Emitter Voltage (Typical)

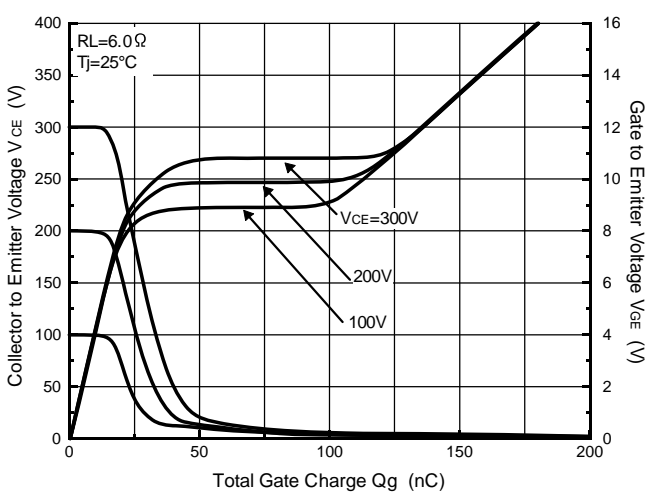

Fig.6- Capacitance vs. Collector to Emitter Voltage (Typical)

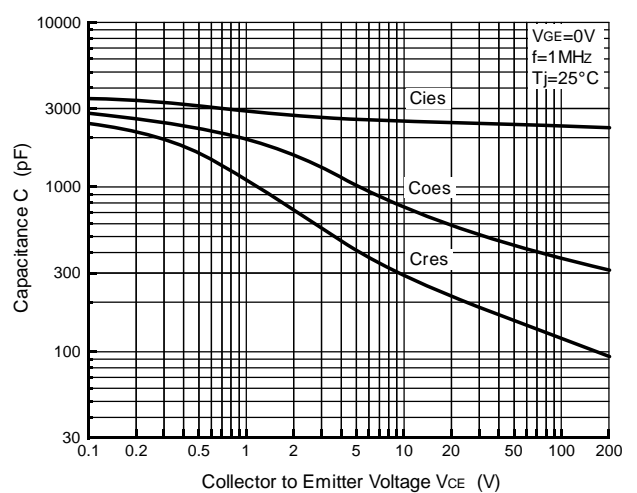

Fig.7- Collector Current vs. Switching Time (Typical)

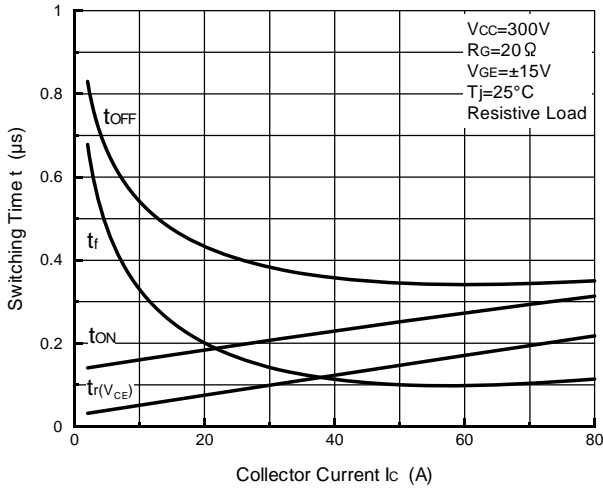

Fig.8- Series Gate Impedance vs. Switching Time (Typical)

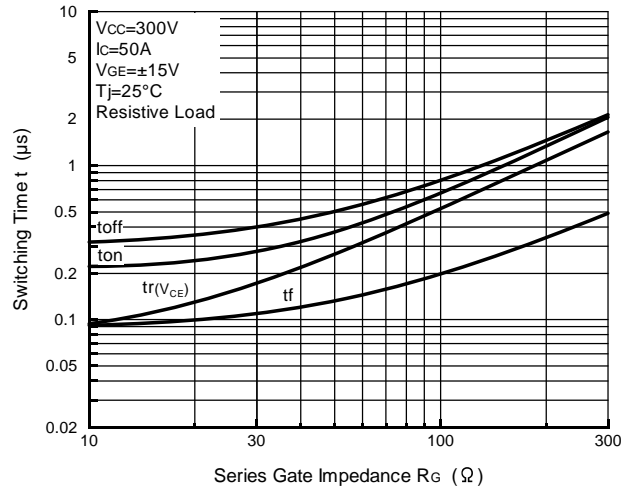

Fig.9- Collector Current vs. Switching Time

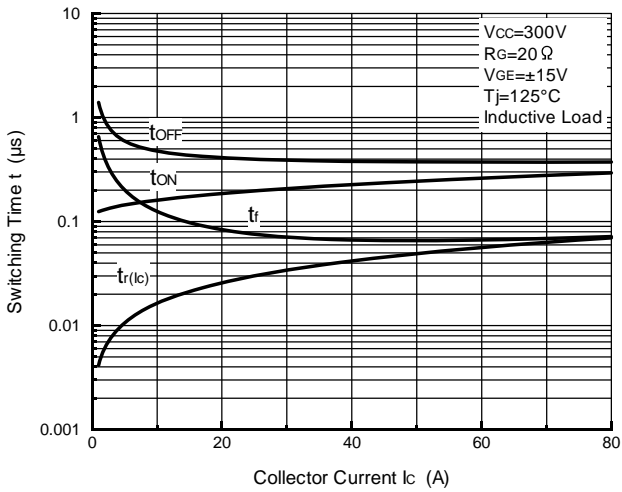

Fig.10- Series Gate Impedance vs. Switching Time

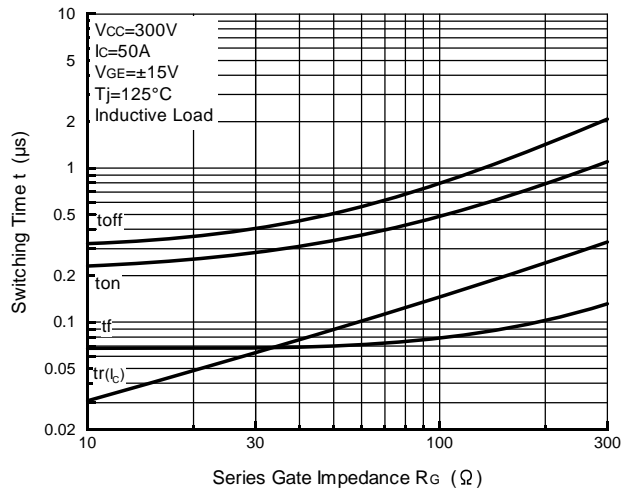

Fig.11- Collector Current vs. Switching Loss

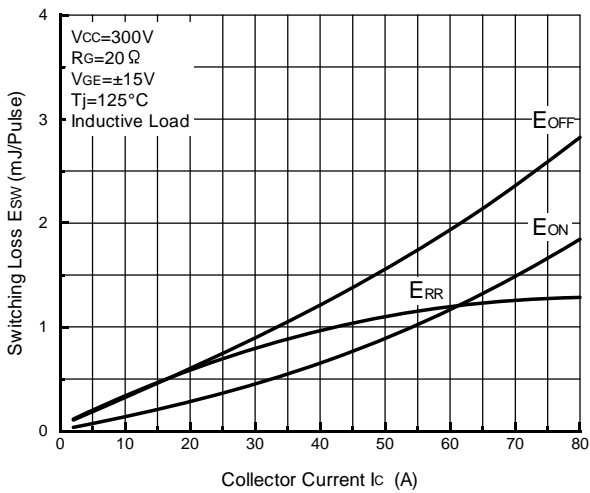

Fig.12- Series Gate Impedance vs. Switching Loss

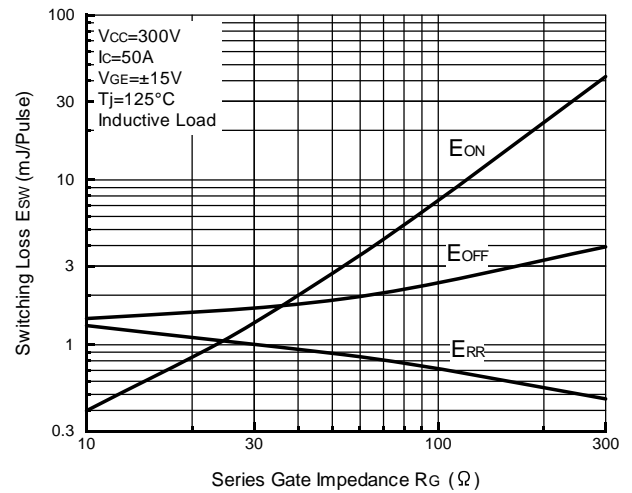

Fig.13- Forward Characteristics of Free Wheeling Diode (Typical)

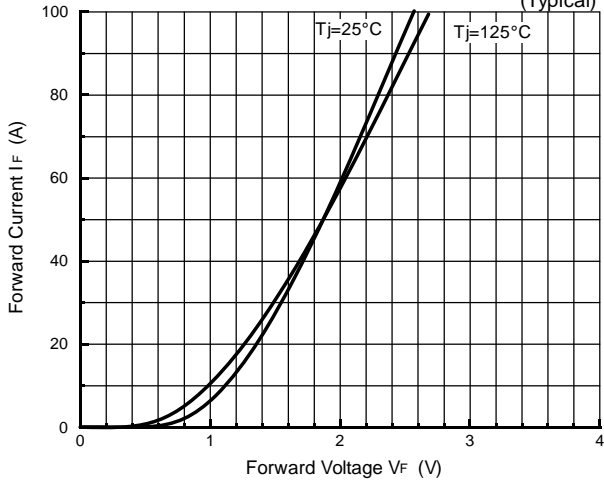

Fig.14- Reverse Recovery Characteristics (Typical)

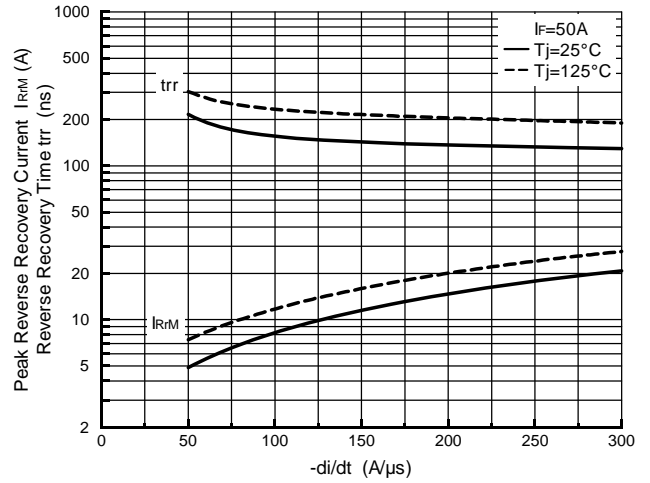

Fig.15- Reverse Bias Safe Operating Area

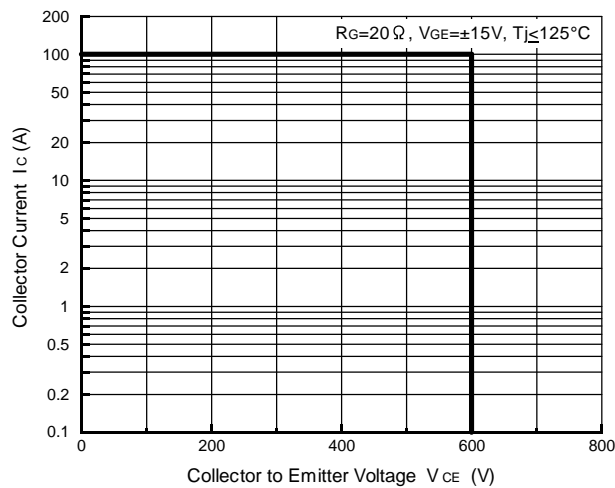

Fig.16- Transient Thermal Impedance

